

Crestron **TPS-6X Series** Isys™ 5.7" Wireless Touchpanels

Operations Guide



This document was prepared and written by the Technical Documentation department at:



Crestron Electronics, Inc.
15 Volvo Drive
Rockleigh, NJ 07647
1-888-CRESTRON

Regulatory Compliance

As of the date of manufacture, the TPS-6X Series has been tested and found to comply with specifications for CE marking and standards per EMC and Radiocommunications Compliance Labelling.



Federal Communications Commission (FCC) Compliance Statement

This device complies with part 15 of the FCC Rules. Operation is subject to the following conditions:

(1) This device may not cause harmful interference and (2) this device must accept any interference received, including interference that may cause undesired operation.

CAUTION: Changes or modifications not expressly approved by the manufacturer responsible for compliance could void the user's authority to operate the equipment.

NOTE: This equipment has been tested and found to comply with the limits for a Class B digital device, pursuant to part 15 of the FCC Rules. These limits are designed to provide reasonable protection against harmful interference in a residential installation. This equipment generates, uses and can radiate radio frequency energy and, if not installed and used in accordance with the instructions, may cause harmful interference to radio communications. However, there is no guarantee that interference will not occur in a particular installation. If this equipment does cause harmful interference to radio or television reception, which can be determined by turning the equipment off and on, the user is encouraged to try to correct the interference by one or more of the following measures:

- Reorient or relocate the receiving antenna
- Increase the separation between the equipment and receiver
- Connect the equipment into an outlet on a circuit different from that to which the receiver is connected
- Consult the dealer or an experienced radio/TV technician for help

Industry Canada (IC) Compliance Statement

Operation is subject to the following two conditions:

1. This device may not cause interference, and
 2. This device must accept any interference, including interference that may cause undesired operation of the device.
-

Contents

Isys™ 5.7" Wireless Touchpanels: TPS-6X Series	1
Introduction	1
Features and Functions	2
Specifications	5
Physical Description	9
Setup	12
Network Wiring	12
Identity Code	12
Battery Switch	13
Configuring the Touchpanel	13
Hardware Hookup	36
Recommended Cleaning	38
Programming Software	39
Earliest Version Software Requirements for the PC	39
Programming with Crestron SystemBuilder	39
Programming with SIMPL Windows	39
Programming with VisionTools Pro-e	45
Uploading and Upgrading	50
Establishing Communication	50
Programs, Projects and Firmware	51
Program Checks	51
Problem Solving	53
Troubleshooting	53
Check Network Wiring	54
Reference Documents	55
Further Inquiries	55
Future Updates	56
Appendix A: The RF Spectrum	57
Appendix B: Optimum RF Reception Guidelines	58
Minimize Interference	58
Gateway Placement	58
Antenna Orientation	58
Software License Agreement	61
Return and Warranty Policies	63
Merchandise Returns / Repair Service	63
CRESTRON Limited Warranty	63

Isys™ 5.7" Wireless Touchpanels: TPS-6X Series

Introduction

The Crestron Isys® TPS-6X Wireless Touchpanels deliver high end style and performance in a very versatile, ergonomic design. With its sleek and innovative desktop docking station, the TPS-6X goes effortlessly from wired tabletop use to fully handheld wireless operation.

Compact and portable, the TPS-6X does away with piles of remotes and cryptic control panels, affording true one-touch control over a broad range of complex devices and systems. Featuring a bright, beautiful, high contrast color touchscreen and a smart array of backlit tactile pushbuttons*, the TPS-6X offers an ideal user interface for controlling home theater and multimedia presentation, as well as a host of other uses.

The TPS-6X and TPS-6XNL are functionally identical. The NL models use a No Lock Docking Station. For simplicity within this guide, the term “TPS-6X” is used except where noted.

The TPS-6X is available in six different models.

Models

DESCRIPTION	MODEL NUMBER	COLOR
Locking Models	TPS-6X	Gloss Black
	TPS-6X-B-T	Matte Black
	TPS-6X-W-S	Gloss White
No Lock Models	TPS-6XNL with No Lock Docking Station	Gloss Black
	TPS-6XNL-B-T with No Lock Docking Station	Matte Black
	TPS-6XNL-W-S with No Lock Docking Station	Gloss White

* Text engraving is not backlit on the white models.

Features and Functions

- Lightweight contoured design for wireless handheld use
- Also affords full featured tabletop tilt touchpanel operation
- Elegant high gloss black or white or matte black finishes
- Non-slip rubber grips on rear
- Illuminated buttons and engravable backlit text¹
- 5.7" active matrix color touchscreen display
- 16-bit Isys™ graphics with 640 x 480 resolution
- Dynamic graphics and text capability
- DNav dynamic menu objects
- Synapse™ image rendering algorithm
- Displays full motion video while docked
- High power, high speed 2.4 GHz RF wireless technology
- Up to 200 feet (61 meters) RF range indoors
- Supports roaming for extended RF coverage
- 1-way IR wireless capability also built in
- Includes tabletop tilt docking station, interface module and NiMH rechargeable battery pack
- Wired Ethernet, Cresnet® and Crestron Home® CAT5 video connectivity
- No-button front bezel option included

Isys™ Color Touchscreen

The TPS-6X provides a wide open canvas for the creation of custom control screens tailored to each unique application. Its brilliant 5.7" active matrix display and powerful Isys engine combine to produce stunning 16-bit color graphics with extreme versatility and lightning fast performance. Dynamic graphics and text capability enable the display of all kinds of useful data and alluring eye candy, from audio settings, TV channels and lighting levels to changing icons, photos and logos, to digital media playlists complete with album cover art.

Crestron® exclusive DNav and Synapse™ technologies enable system programmers to produce amazing graphics faster and easier using advanced dynamic control menus and 3D effects. Additional capabilities like animations, multimode objects, PNG translucence and full motion video² enhance the palette for creating GUIs that are both eye catching and easy to use.

Tactile Pushbuttons

In addition to its touchscreen, the TPS-6X features illuminated tactile pushbuttons for quick access to volume adjustment, channel selection and on-screen menu navigation functions. Eight additional pushbuttons, elegantly trimmed by illuminated button dividers, flank the edges of the touchscreen to support additional programmable functions.

1. Text engraving is not backlit on the white models.

2. Requires a wired connection via the included docking station and interface module.

High quality backlit laser engraving lends a crisp, legible appearance to button text in both darkened and fully lit rooms¹. The pushbuttons come pre-engraved with labeling suited to a typical home theater or multimedia presentation application. If needed, customized engraving can be attained simply using Crestron Engraver software. A no-button front bezel is also included with the TPS-6X, which may be installed in place of the button bezel for a very clean appearance with no front panel pushbuttons.

Two additional “trigger” style buttons are positioned on top of the TPS-6X for easy control of the display brightness, *Sleep* mode and other programmable functions.

High Powered Wireless

The TPS-6X brings a new level of wireless versatility to the Isys family of touchpanels. With both 2-way RF and 1-way IR wireless capabilities built in, the TPS-6X offers a choice of wireless platforms to suit the environment.

Crestron high power 2.4 GHz RF technology allows long range performance up to 200 feet (61 meters) indoors² using the CEN-HPRFGW High Powered RF Gateway (sold separately). For even greater coverage, the TPS-6X supports roaming among up to eight RF gateways. A range of selectable RF channels and power levels helps to maximize performance for both small and large facilities, from boardrooms, classrooms and home theaters to auditoriums and convention centers. High speed bidirectional communication supports true feedback with dynamic graphics and text, affording the capabilities of a wired Isys touchpanel in a fully wireless portable package.

Built in IR capability affords a wireless alternative that is immune to extremely noisy RF environments and suitable for sensitive applications where RF may not be permitted. An operational range of up to 50 feet (15 meters) line-of-sight is possible using a C2N-IRGW IR Gateway or CNXRMIRD IR Receiver (both sold separately).

TableTop Tilt Docking Station

Placing the touchpanel onto the TPS-6X-DS (or with the TPS-6XNL models, the TPS-6XNL-DS) Docking Station (included) converts it to a stylish tilt touchpanel, providing wired communications and video capability while charging the touchpanel's internal battery. Both wired Ethernet and Cresnet[®] connectivity are available so when the touchpanel is placed on the docking station, it can switch automatically from RF wireless to fully wired operation if either Ethernet or Cresnet is connected. Without a wired connection present, the touchpanel will continue to operate wirelessly while it charges.

The docking station features a tiltable docking port, allowing the touchpanel to be tilted at any angle up to 45 degrees for optimal viewing and operation when docked. The angle can be freely adjusted or locked down at a fixed angle³. Strong magnets help guide the touchpanel onto the docking port and hold it in place and a finger operated latch can be engaged at any time to secure the touchpanel to the docking station³. The touchpanel can even be attached to the docking station semi-permanently for a sleek, full time tabletop touchpanel solution³.

A single cable exits the rear of the docking station base, extending to a wall or surface mounted TPS-6X-IMCW Interface Module (included). The cable can also be repositioned to exit the bottom for a very clean, cordless appearance.

1. Text engraving is not backlit on the white models.

2. 100 to 200 feet (30-61 meters) indoor range, subject to site specific conditions.

3. Models with “No Lock” docking stations omit the finger operated latch and locking pin features.

Full Motion Video

When docked, the TPS-6X can display full motion video*, providing the ability to monitor a security camera or preview a DVD or television channel, right on the touchscreen display. The video image is fully scalable for viewing in any size window or full screen. The choice of balanced or unbalanced composite inputs allows compatibility with both conventional coaxial and Crestron Home® Balanced AV distribution systems.

* Requires a wired connection via the included docking station and interface module.

Specifications

Specifications for the TPS-6X are listed in the following table.

TPS-6X Specifications

SPECIFICATION	DETAILS
Touchscreen Display Display Type Size Aspect Ratio Resolution Brightness Contrast Color Depth Illumination Viewing Angle Touchscreen	TFT Active matrix color LCD 5.7 inch (14.48 cm) diagonal 4:3 QVGA 640 x 480 pixels 350 nits 400:1 18-bit, 256 k colors Backlit fluorescent ±80° horizontal, +80°/-70° vertical Resistive membrane
Processor CPU	32-bit Freescale ColdFire® Microprocessor
Memory SDRAM Flash Maximum Project Size	32 MB 32 MB 28 MB
Graphic Engine	Isys engine; 16-bit non-palette graphics; 65,536 colors; Synapse™ image rendering algorithm; multi-mode objects; DNav dynamic menu objects; dynamic graphics; PNG translucence, full motion (60 fps) animation; color key video windowing
RF Wireless RF Transceiver Transmitting Power Range Gateway Roaming	2-way RF, 2.4 GHz ISM Channels 11-26 (2400 to 2483.5 MHz), IEEE 802.15.4 compliant 75 mW (Ch. 11), 100 mW (Ch. 12-23), 15 mW (Ch. 24), 3.5 mW (Ch. 25), 1 mW (Ch. 26) @ High setting; 1 mW (Ch. 11-25), 0.5 mW (Ch. 26) @ Low setting 100-200 feet (30-61 meters) maximum indoor, 1000 feet (305 meters) outdoor, subject to site-specific conditions Requires a CEN-HPRFGW RF Gateway (sold separately) Supports roaming among up to eight RF gateways

(Continued on following page)

TPS-6X Specifications (Continued)

SPECIFICATION	DETAILS
IR Wireless ¹	
IR Transmitter	38 kHz, RC5 format
Range	50 feet (15 meters) typical
Gateway	Requires a C2N-IRGW IR Gateway or CNXRMIRD IR Receiver (both sold separately)
Wired Communications ²	
Ethernet	10BASE-T/100BASE-TX, auto-switching, auto-negotiating, auto-discovery, full/half duplex, TCP/IP, UDP/IP, CIP, DHCP
Cresnet	Supports Cresnet slave mode
Video ²	
Signal Types	Composite
Formats	NTSC 480i or PAL 576i
Color Depth	18-bit, 262,144 colors
Windowing	Single window, deinterlaced and scalable up to full screen
Audio	Internal transducer for key click sound
Battery	
Internal Battery	NiMH, 4.8 Volt, 2000 mAh, model TPS-6X-BTP (included)
Usage Per Charge	~2 hours continuous, 2 days under normal use with factory settings
Charging Time ³	~2.5 hours (~2.5 to 3 hours when in use)
Power Requirements ⁴	
Power Pack	0.75 Amps @ 24 Volts DC, 100-240 Volts AC 50/60 Hz power pack included
Cresnet Power Usage	18 Watts (0.75 Amps @ 24 Volts DC) TPS-6X-IMCW module included
Default Net ID	03
Minimum 2-Series Control System Update File ^{5, 6, 7}	Version 3.155.1240 or later
Environmental	
Temperature	32° to 112°F (0° to 45°C) 50° to 104°F (10° to 40°C) while charging
Humidity	10% to 90% RH (non-condensing)
Heat Dissipation	61 BTU/Hr

(Continued on following page)

TPS-6X Specifications (Continued)

SPECIFICATION	DETAILS
Enclosure	
Construction	Injection molded plastic, non-slip grips/feet, integral docking station port
Front Bezels	Button and no button bezels included; button bezel includes white translucent illuminated Up/Down and Thumbpad buttons and eight hard key buttons with illuminated dividers and default backlit ⁸ text engraving, optional custom backlit ⁸ text engraving sold separately
Dimensions	
Height	5.10 in (130 mm)
Width	8.08 in (206 mm)
Depth	1.57 in (40 mm)
Weight	1.6 lbs (720 g)
Available Models (Locking)	
TPS-6X	Isys 5.7" Wireless Touchpanel, Gloss Black
TPS-6X-B-T	Isys 5.7" Wireless Touchpanel, Matte Black
TPS-6X-W-S	Isys 5.7" Wireless Touchpanel, Gloss White
Available Models (No Lock)	
TPS-6XNL	Isys 5.7" Wireless Touchpanel with No Lock Docking Station, Gloss Black
TPS-6XNL-B-T	Isys 5.7" Wireless Touchpanel with No Lock Docking Station, Matte Black
TPS-6XNL-W-S	Isys 5.7" Wireless Touchpanel with No Lock Docking Station, Gloss White
Included Accessories	
Power Pack	24 Volt Power Pack, Universal
TPS-6X-BTP	Internal Battery Pack
TPS-6X-DS	Desktop Docking Station (specify color) for TPS-6X models only
TPS-6X-FP	Button Bezel with Default Engraving (specify color)
TPS-6X-FP-NB	No Button Bezel (specify color)
TPS-6X-IMCW	Interface Module
TPS-6XNL-DS	Desktop Docking Station (specify color) for TPS-6XNL models only
Available Accessories	
C2N-IRGW-1G	Wall Mount IR Gateway
C2N-IRGW-F	Flush Mount IR Gateway
CEN(I)-HPRFGW	High Powered RF Gateway
CNXRMIRD	IR Receiver
SMK-6X	Swivel Mount Kit
TPS-6X-DS-C	Desktop Docking Station, Charging only (specify color) for TPS-6X models only

(Continued on following page)

TPS-6X Specifications (Continued)

SPECIFICATION	DETAILS
Available Accessories (Continued) TPS-6X-DSW TPS-6X-FP TPS-6XNL-DS-C	Wall Mount Docking Station (specify color) Button Bezel with Custom Engraving (specify color) Desktop Docking Station, No Lock, Charging only (specify color) for TPS-6XNL models only

1. When IR is enabled, the RF transceiver is disabled and wired communication is restricted to console functions only (i.e. programming and configuration).
2. Requires a wired connection via the included docking station and interface module.
3. When the battery switch on the rear of the unit has been in the OFF position, as when the unit is shipped or stored, the TPS-6X should be placed on its docking station/charger for a minimum of four hours before using. Refer to “Battery Switch” on page 13 for details.
4. May be powered by 24 Volts DC or Cresnet network power but not both. All power connections are made via the included TPS-6X-IMCW interface module.
5. The latest software versions can be obtained from the Crestron® website. Refer to the NOTE following these footnotes.
6. Crestron 2-Series control systems include the AV2 and PRO2. Consult the latest Crestron Product Catalog for a complete list of 2-Series control systems.
7. When loading VisionTools® Pro-e (VT Pro-e) files or firmware through the RS-232 port of the control system, be sure that the baud rate is at 38400 (Cresnet speed) or lower. Otherwise, Crestron Toolbox™ may post the “Transfer Failed” message.
8. Text engraving is not backlit on white models.

NOTE: Crestron software and any files on the website are for authorized Crestron dealers and Crestron Authorized Independent Programmers (CAIP) only. New users may be required to register to obtain access to certain areas of the site (including the FTP site).

Physical Description

This section provides information on the connections, controls and indicators available on your TPS-6X.

TPS-6X Physical View (Front)



TPS-6X Physical View (Rear)



TPS-6X Overall Dimensions (Front and Side Views)

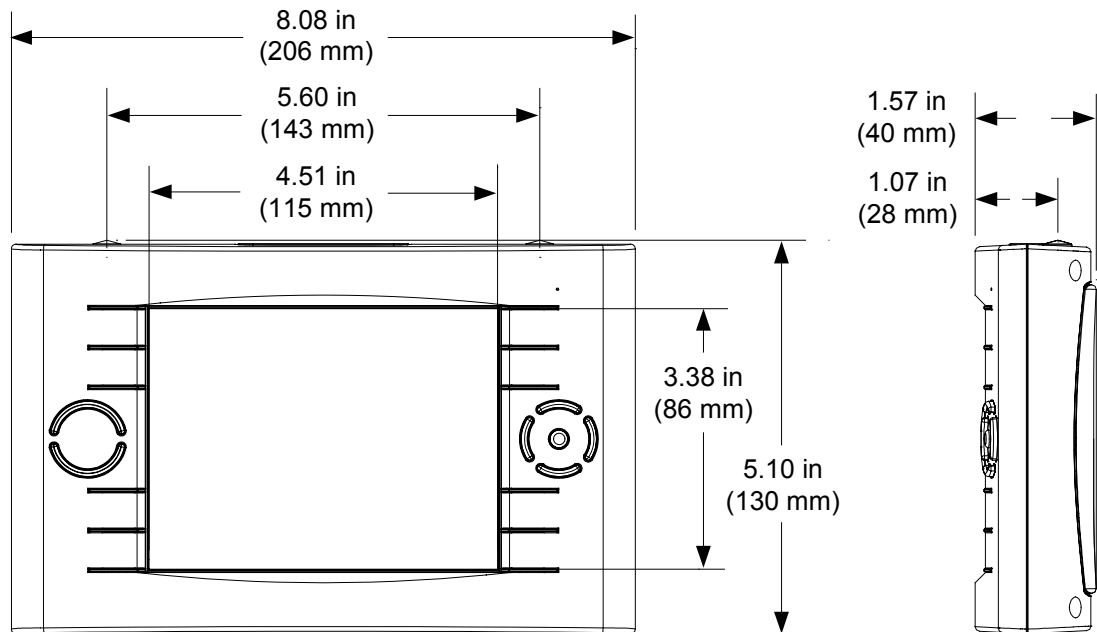

TPS-6X Overall Dimensions (Rear View)

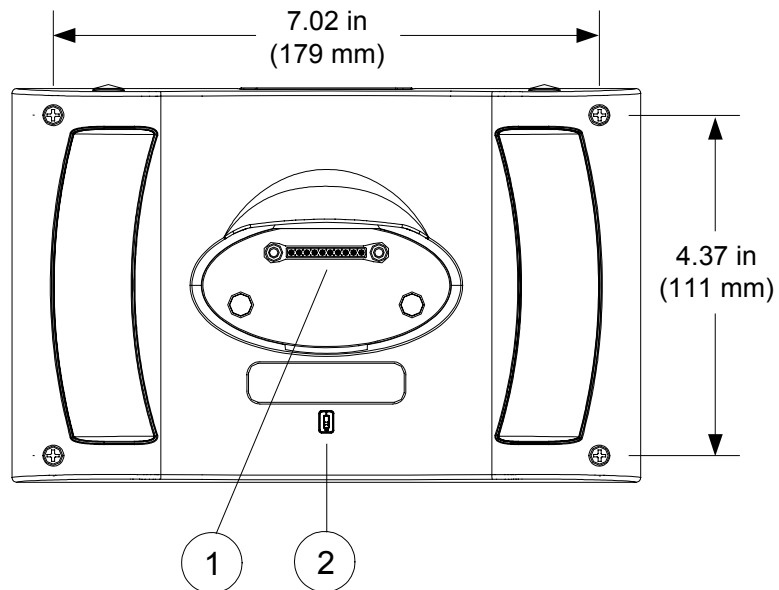

TPS-6X (Top View)

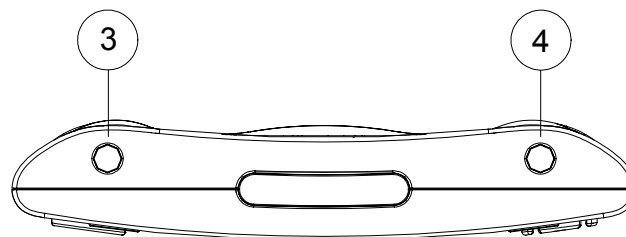

TPS-6X (Front View)

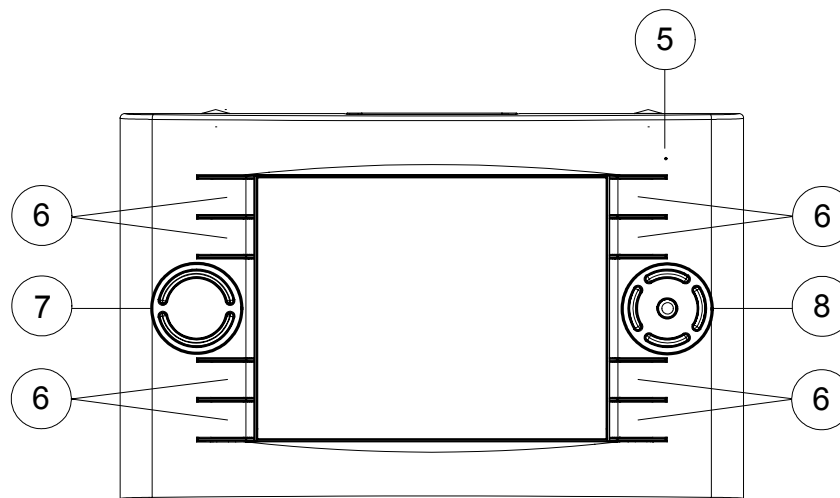

Connectors, Controls & Indicators

#	CONNECTORS, CONTROLS & INDICATORS	DESCRIPTION
1	DOCKING STATION CONNECTOR	(1) Multi-pin connector; mates with the docking port on the TPS-6X-DS (or TPS-6XNL-DS) Docking Station.
2	BATTERY SWITCH	(1) Rear panel recessed DIP switch, shuts off battery for long term storage.
3	SLEEP	(1) Programmable top-mounted pushbutton (left “trigger” key), initiates <i>Sleep</i> mode when docked; turns power on/off when undocked; also resets touchpanel if held for five seconds, starting up at first page of the installed project.
4	BRIGHTNESS	(1) Programmable top-mounted pushbutton (right “trigger” key), normally sets display brightness level. Toggles between high, medium, low and standby. Toggling can be enabled/disabled from setup menu (refer to “BACKLIGHT” which starts on page 33 for details).
5	BATTERY LED	(1) Green LED, indicates battery condition and charging status when docked. Flashing indicates battery is charging; Steady on indicates battery is fully charged.
6	HARD KEYS	(8) Optional programmable pushbuttons; engravable backlit* text (sold separately); default engraving included.
7	UP/DOWN	(2) Optional programmable “up/down” pushbuttons, backlit, engravable backlit* text on bezel (sold separately); default engraving included.
8	THUMBPAD	(5) Optional programmable pushbuttons for 4-way directional navigation and “enter”, backlit.

* Text engraving is not backlit on white models.

Setup

Network Wiring

When wiring the Cresnet or Ethernet network, consider the following:

- Use Crestron Certified Wire.
- Use Crestron power supplies for Crestron equipment.
- Provide sufficient power to the system.

CAUTION: Insufficient power can lead to unpredictable results or damage to the equipment. Please use the Crestron Power Calculator to help calculate how much power is needed for the system (www.crestron.com/calculators).

Cresnet

For larger networks, use a Cresnet Hub/Repeater (CNXHUB) to maintain signal quality.

For more details, refer to “Check Network Wiring” which starts on page 54.

Ethernet

The TPS-6X can also use high-speed Ethernet for communications between the device and a control system, computer, digital media server and other IP-based devices.

For information on connecting Ethernet devices in a Crestron system, refer to the latest version of the Crestron e-Control® Reference Guide (Doc. 6052), which is available from the Crestron website (www.crestron.com/manuals).

Identity Code

Net ID

The Net ID of the TPS-6X has been factory set to **03**. The Net IDs of multiple TPS-6X devices in the same system must be unique. The Net ID is set using the internal setup menu (refer to “CRESNET” on page 32). Net ID may also be set from a personal computer (PC) via Crestron Toolbox™ (refer to “Establishing Communication” which starts on page 50).

When setting the Net ID, consider the following:

- The Net ID of each unit must match an ID code specified in the SIMPL™ Windows program.
- Each network device must have a unique Net ID.

For more details, refer to the Crestron Toolbox help file.

IP ID

The IP ID is set within the TPS-6X’s table using the internal setup menu (refer to “COMM” which starts on page 19). The IP ID may also be set from a personal computer (PC) using Crestron Toolbox. For information on setting an IP table, refer to the Crestron Toolbox help file. The IP IDs of multiple TPS-6X devices in the same system must be unique.

When setting the IP ID, consider the following:

- The IP ID of each unit must match an IP ID specified in the SIMPL Windows program.

- Each device using IP to communicate with a control system must have a unique IP ID.

RF ID

Every TPS-6X touchpanel communicating via RF with a Cresnet control system through a CEN(I)-HPRFGW gateway requires a unique RF ID. The RF ID is a two-digit hexadecimal number that can range from 03 to 12. The RF ID of the unit, set using the internal setup menu (refer to “WIRELESS” which starts on page 27) or in Crestron Toolbox, must match the RF ID specified in the SIMPL Windows program.

IR ID

Every TPS-6X touchpanel communicating via IR with a Cresnet control system through a CNXRMIRD receiver, a C2N-IRGW gateway or directly with an MC2W control system, requires a unique IR ID to secure IR communications. There are two useable codes (two-digit hexadecimal numbers): 00 and 10; the default is 00. The IR ID of the unit, set using the internal setup menu (refer to “WIRELESS” which starts on page 27), must match the IR ID specified in the SIMPL Windows program.

Battery Switch

The TPS-6X ships with the battery switch (on the rear) in the OFF (downward) position. The OFF position is used for shipping and long term storage only.

Use the included T-pin to turn the switch ON (slide it upward) and place the TPS-6X on the included docking station/charger for a minimum of four hours before using.

NOTE: When the TPS-6X is on the docking station/charger, the front panel battery LED will flash to indicate the battery is charging. When fully charged, it will remain on, without flashing.

To charge the internal battery, the TPS-6X must be placed on the TPS-6X-DS (or with the TPS-6XNL models, the TPS-6XNL-DS) Docking Station, which must be connected to a powered TPS-6X-IMCW Interface Module (both included).

Configuring the Touchpanel

NOTE: The only connection required to configure the touchpanel is power. Refer to “Hardware Hookup” which starts on page 36 for details.

To configure the TPS-6X it may be necessary to access a series of setup menus prior to viewing run-time screens that are loaded into the touchpanel for normal operation. The MAIN MENU is the starting point for configuring the touchpanel.

NOTE: If no project has been loaded or if an invalid project has been loaded, the touchpanel displays an error message and asks the user to touch the screen to enter setup, which defaults to the MAIN MENU.

NOTE: Trigger key functionality is not available in the setup menus.

If a project is running, the MAIN MENU can be accessed using one of two methods: via the trigger keys on the top of the touchpanel or via Crestron Toolbox.

Via the Trigger Keys

1. Press and hold the right trigger key on the top of the touchpanel and at the same time, touch the upper right corner of the screen.

2. Continue holding the right trigger key and touching the upper right corner of the screen. At the same time, press and hold the left trigger key on the top of the touchpanel. After four seconds, the panel will reset.
3. Once the screen turns black, release the left trigger key and the panel will enter the MAIN MENU, as shown in the illustration below.
4. Release the right trigger key and the touch screen.

Via Crestron Toolbox

1. Establish communication with the touchpanel (refer to “Establishing Communication” which starts on page 50 for details).
2. Right-click on the device and select **Functions | Setup Mode....**
3. Select **Enter Setup Mode**. The MAIN MENU will be displayed, as shown in the illustration below.

NOTE: Select **Exit Setup Mode** to exit the setup menu.

The MAIN MENU displays four large buttons: **Touch Screen Calibration**, **Exit and Run Program**, **Setup** and **Diagnostics**, as shown in the following illustration.

MAIN MENU

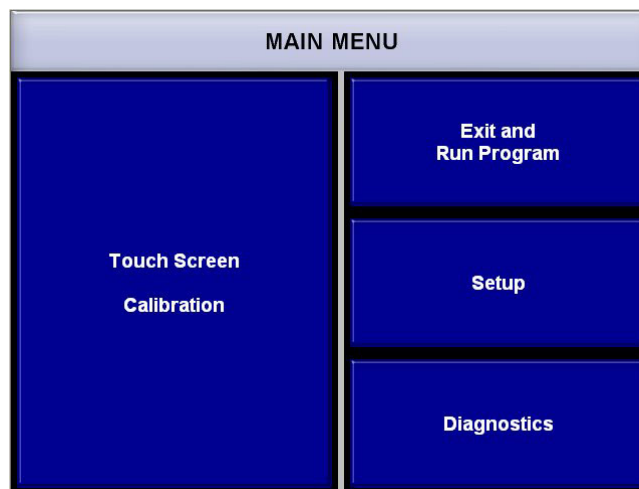

The **Exit and Run Program** button verifies that all of the setup information has been saved to the EEPROM and displays the main page that has been programmed into your system. The remaining buttons on the MAIN MENU open other menus and displays which are discussed in subsequent paragraphs.

CALIBRATION MENU

Touch the **Touch Screen Calibration** button to enter the CALIBRATION MENU.

CALIBRATION MENU

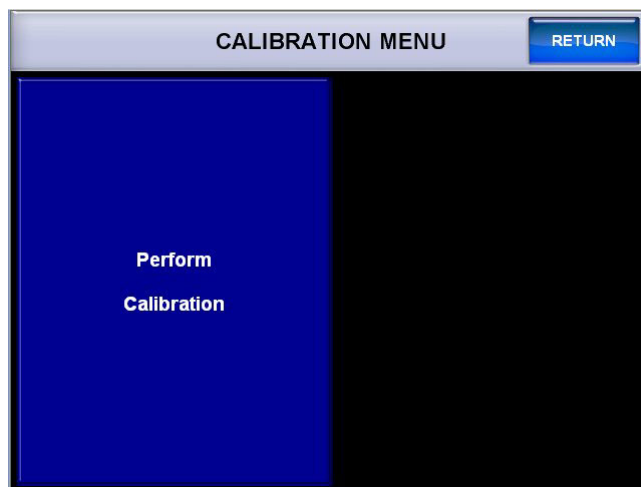

Touch **Perform Calibration**. The message “Touch Upper Left +” appears centered on the panel with a crosshair in the upper left corner. Touch the center of the crosshair in the corner of the screen to initiate calibration. Another message, “Touch Upper Right +”, appears with a crosshair in the correct corner. Touch the center of the crosshair in the corner of the screen. A final message, “Touch Lower Right +”, appears with the crosshair in the correct corner. Touch the center of the crosshair in the corner of the screen to conclude calibration and return to the MAIN MENU.

NOTE: When touching the screen during calibration, be as accurate as possible. Use the tip of a capped pen or the eraser end of a pencil. To cancel calibration and return to the MAIN MENU without saving calibration data, create a calibration error by touching the screen in the same spot two times. If calibration has not been started, you can return to the MAIN MENU by touching **RETURN**.

SETUP

To enter the SETUP MODE menu, touch **Setup** on the MAIN MENU.

SETUP MODE Menu

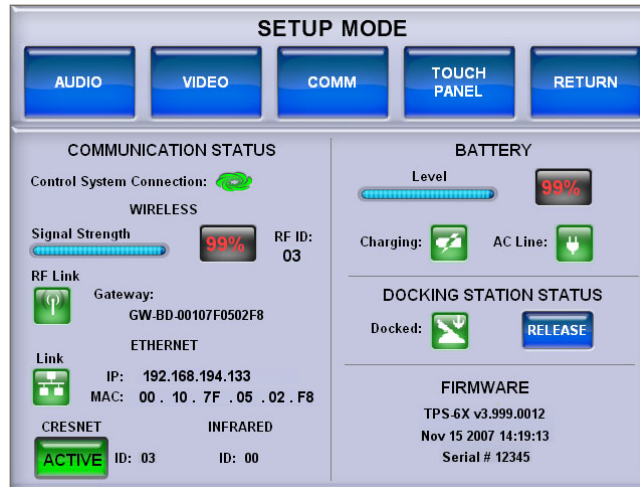

The SETUP MODE menu offers a series of buttons which open additional menus and displays that are detailed in subsequent paragraphs. After setup parameters have been selected, touch **RETURN** to go to the previous menu. When all setup parameters have been selected, touch **RETURN** repeatedly to go back to the MAIN MENU.

NOTE: All touchpanel settings are automatically saved in non-volatile memory.

The SETUP MODE menu also provides data for *COMMUNICATION STATUS*, *BATTERY*, *DOCKING STATION STATUS* and *FIRMWARE*.

The Crestron Swirl logo  in the *COMMUNICATION STATUS* section illuminates to indicate the status of your connection to the control system(s). For details, refer to “COMM” which starts on page 19.

The *COMMUNICATION STATUS* section also displays wireless signal strength, RF ID, gateway connection and ID, Ethernet connection, IP and MAC addresses, Cresnet connection status and ID and infrared ID.

The *BATTERY* section displays battery charge level and has indicators to show when the battery is charging and when AC power is connected.

NOTE: When battery power is low, the TPS-6X will show a warning message. The key backlight will be turned off and the display backlight will dim to minimum until the battery is recharged or the unit is docked. If battery power drops to 4%, saving of panel settings is not guaranteed.

NOTE: The battery charge level percentage indicator gets more accurate after a few charge/discharge cycles. Periodic full discharge (i.e. once a month) is recommended to maintain accuracy of the percentage measurement.

The *DOCKING STATION STATUS* section has an indicator to show docked status. The **RELEASE** button is used to release the touchpanel from its (optional) TPS-6X-DSW docking station.

NOTE: The TPS-6X determines that it is “docked” by the presence of power. The indicator will only show it as *DOCKED* (and video will only be available) when it is connected to a TPS-6X-IMCW Interface Module (included) that is receiving power.

The *FIRMWARE* section displays the firmware version, date and time of the firmware build and the touchpanel serial number.

AUDIO

From the SETUP MODE menu, touch **AUDIO** to enter the AUDIO SETUP menu.

AUDIO SETUP Menu

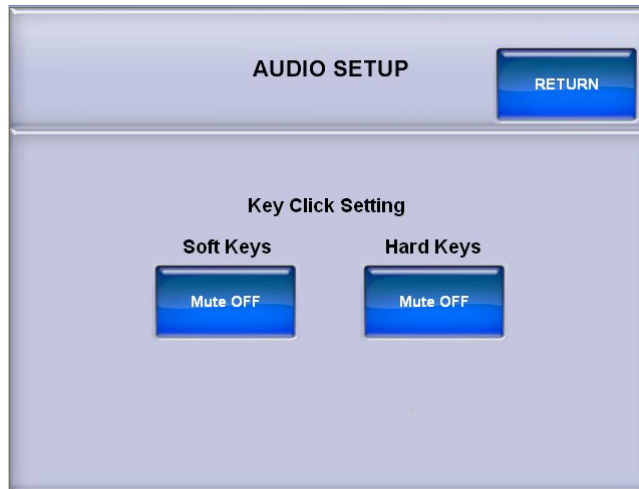

The AUDIO SETUP menu offers a pair of buttons that allow muting of the key click sound for either the *Soft Keys* (on screen buttons) or the *Hard Keys* (buttons on the front of the touchpanel).

Refer to the following table for additional AUDIO SETUP menu details.

Audio Setup Details

AUDIO SETUP SCREEN CONTROL	DESCRIPTION
Soft Keys Mute	Toggles the key click sound for on screen soft key presses.
Hard Keys Mute	Toggles the key click sound for touchpanel hard key presses.

After audio parameters have been set, touch **RETURN** to go back to the SETUP MODE menu or MAIN MENU.

VIDEO

From the SETUP MODE menu, touch **VIDEO** to enter the VIDEO SETUP menu.

VIDEO SETUP Menu

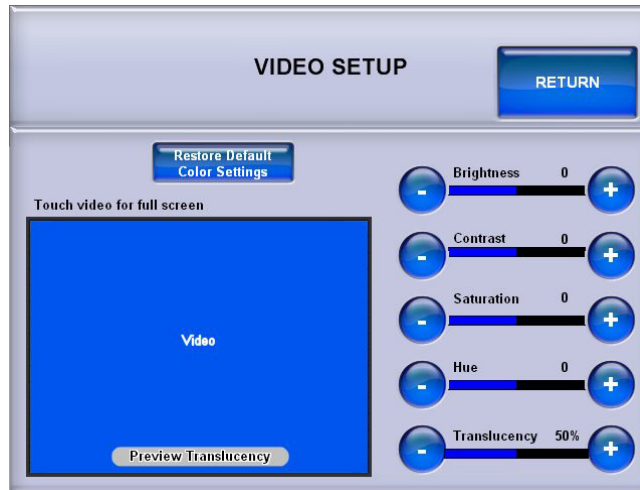

The VIDEO SETUP menu offers a series of buttons that adjust video *Brightness*, *Contrast*, *Saturation*, *Hue* and *Translucency*. The **Restore Default Color Settings** button will return all of these controls to their factory defaults.

Refer to the following table for additional VIDEO SETUP menu details.

Video Setup Details

VIDEO SETUP SCREEN CONTROL	DESCRIPTION
Restore Default Color Settings	Returns video settings to their factory defaults.
Brightness	Adjusts video image brightness with the – and + buttons.
Contrast	Adjusts video image contrast with the – and + buttons.
Saturation	Adjusts video image saturation with the – and + buttons.
Hue	Adjusts video image hue with the – and + buttons.
Translucency	Adjusts video image translucency with the – and + buttons.

The *Preview Translucency* area of the video screen within the VIDEO SETUP menu will show the effects of different settings of the *Translucency* controls.

NOTE: *Preview Translucency* requires an actual video signal input to the touchpanel in order to show the effects of the *Translucency* controls.

NOTE: The TPS-6X will display video only when it is docked and when the TPS-6X-IMCW Interface Module (included) is receiving power.

Touching the video screen within the VIDEO SETUP menu provides a full screen view, as shown in the following illustration.

Full Screen View

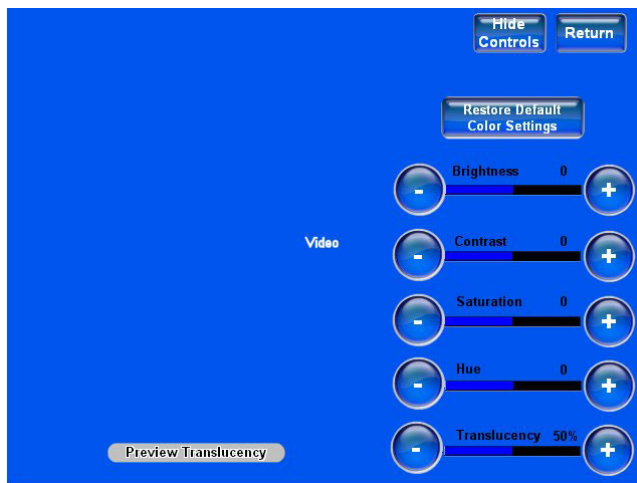

The **Hide Controls** button removes the **Restore Default Color Settings** button and the *Brightness, Contrast, Saturation, Hue* and *Translucency* controls from the screen. Touch **Return** to go back to the VIDEO SETUP menu. After video parameters have been set, touch **RETURN** to go back to the SETUP MODE menu or MAIN MENU.

COMM

From the SETUP MODE menu, touch **COMM** to enter the COMMUNICATIONS menu.

COMMUNICATIONS Menu

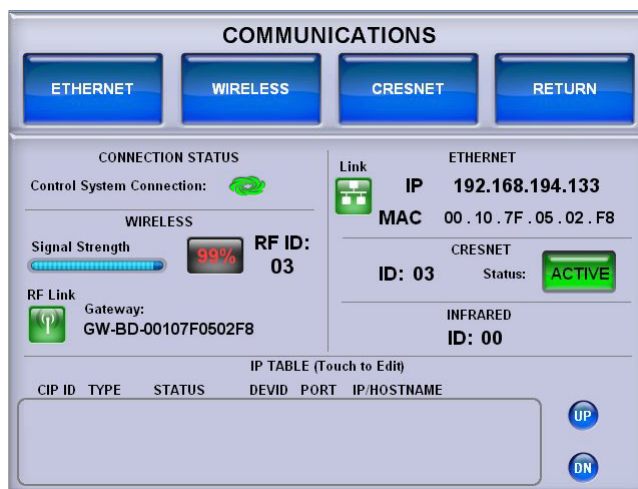

The COMMUNICATIONS menu offers a series of buttons (i.e. **ETHERNET**, **WIRELESS** and **CRESNET**) which open additional menus and displays that are detailed in subsequent paragraphs. After communication parameters have been selected, touch **RETURN** to go to the previous menu. When all communication parameters have been selected, touch **RETURN** repeatedly to go back to the SETUP MODE menu or MAIN MENU.

The TPS-6X has three independent means of connecting to a control system: Ethernet, Cresnet and Radio (RF). The Crestron Swirl logo  in the *CONNECTION STATUS* section illuminates to indicate the status of your connection to the control system(s):

- Green Connected (via Ethernet, Cresnet or RF)
- Blue Connected to some but not all of the control systems listed in IP table (Ethernet only)
- Yellow Network trouble (no CIP communication with a control system, no Cresnet packets addressed to panel or CEN(I)-HPRFGW is not communicating with a control system)
- Red Not connected to any control system (via Ethernet, Cresnet or RF)

The *COMMUNICATIONS* menu also provides data for wireless signal strength, RF ID, gateway connection and ID, Ethernet connection, IP and MAC addresses, Cresnet connection status and ID and infrared ID.

The *IP TABLE* section at the bottom of the *COMMUNICATIONS* menu will show all current IP table entries and provides **UP** and **DN** buttons which allow you to scroll through the list.

To create a new IP table entry or to edit an existing one, touch the rectangle within the *IP TABLE* section of the menu to enter the *IP TABLE EDITOR*.

IP TABLE EDITOR (IP ADDRESS)



The *IP TABLE EDITOR* offers the option of entering the information as an IP address (as shown in the illustration above) or as a hostname (as shown in the following illustration). Simply touch **IP ADDRESS** or **HOSTNAME** to switch between the two methods.

IP TABLE EDITOR (HOSTNAME)

To add an IP address (or hostname), use the **DN** and **UP** buttons to select the *CIP ID*. Then use the numeric keypad on the screen for IP address entry or touch **HOSTNAME** to switch to the alphanumeric keypad. When both the *CIP ID* and IP address (or hostname) have been entered, touch **ADD IP** to add the entry to the list.

To remove an IP address (or hostname), select the appropriate *CIP ID* and type in the IP address (or hostname), then touch **REMOVE IP**.

To clear the entry area just above the keypad on the screen, touch **Clear IP/Host**.

The IP TABLE EDITOR also has **DN** and **UP** buttons for the optional *DEV ID* and *PORT* settings. Touch the **Default Port** button to reset the *PORT* to its factory default setting.

To verify the latest status of connections listed in the IP table, touch **Update IP Table**.

ETHERNET

Touch **ETHERNET** to enter the ETHERNET SETUP menu.

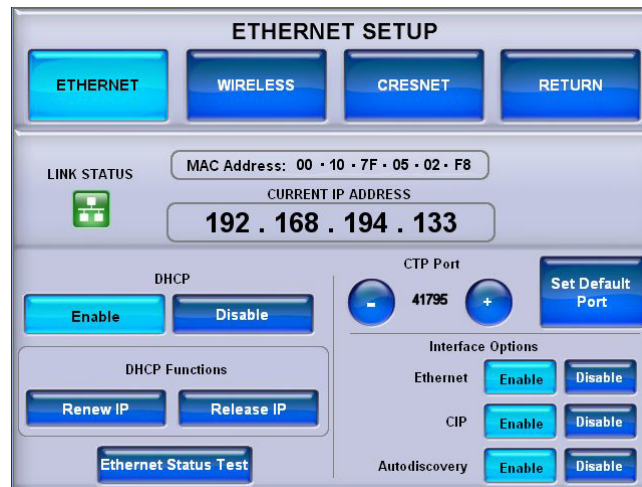
ETHERNET SETUP Menu

The ETHERNET SETUP menu offers a series of buttons which open additional menus and displays that are detailed in subsequent paragraphs. After Ethernet parameters have been selected, touch **RETURN** to go to the previous menu. When all parameters have been selected, touch **RETURN** repeatedly to go back to the SETUP MODE menu or the MAIN MENU.

The ETHERNET SETUP menu also provides information on Ethernet link status, MAC and IP addresses, - and + controls to set the *CTP Port*, a **Set Default Port** button to return the CTP Port setting to its factory default and buttons to **Enable** or **Disable Ethernet**, *CIP* and *Autodiscovery*.

By default, DHCP is enabled. To use a static IP address, touch the **Disable** button under *DHCP*. The *DHCP Functions* section of the menu, with the **Renew IP** and **Release IP** buttons, will change to a *Static IP Settings* section, with **IP Address** and **DNS Servers** buttons. A new **Reboot required for settings to take effect. Reboot Now** button will appear, as shown in the following illustration.

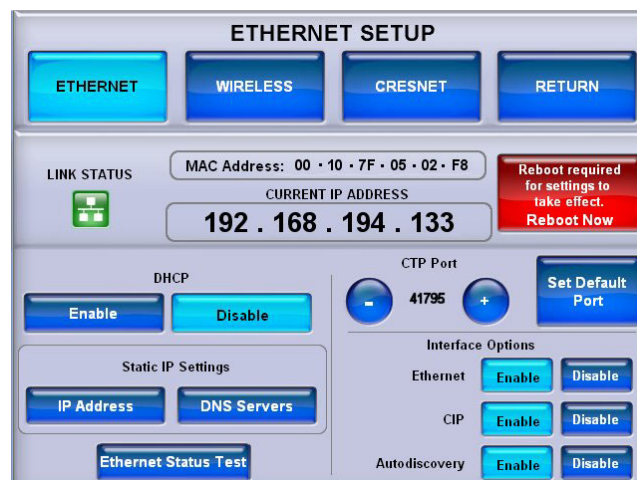
ETHERNET SETUP Menu (DHCP Disable)

Touch **IP Address** to enter the STATIC IP SETTINGS menu, as shown in the following illustration.

ETHERNET SETUP (STATIC IP SETTINGS Menu)

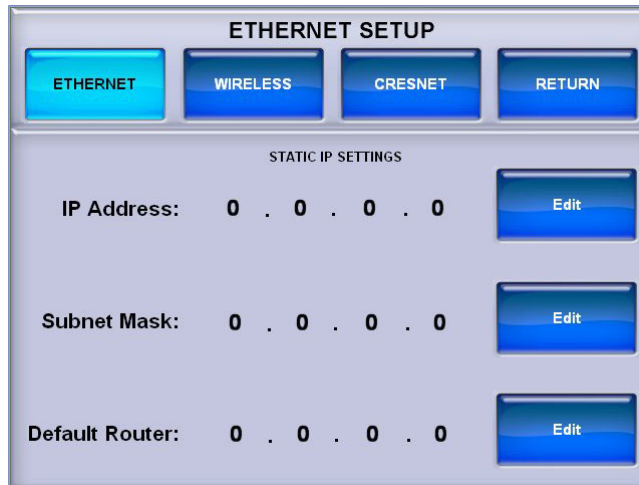

From the STATIC IP SETTINGS menu, touch the **Edit** buttons to enter the menus that allow you to set the *IP Address*, *Subnet Mask* and *Default Router*, as shown in the following illustrations. + and – buttons on each menu are provided for setting the numbers. In each case, touch **RETURN** to go back to the previous menu.

ETHERNET SETUP (EDIT IP ADDRESS Menu)

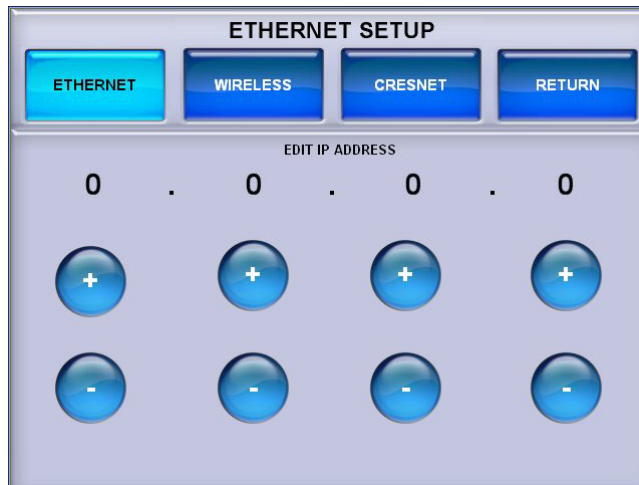

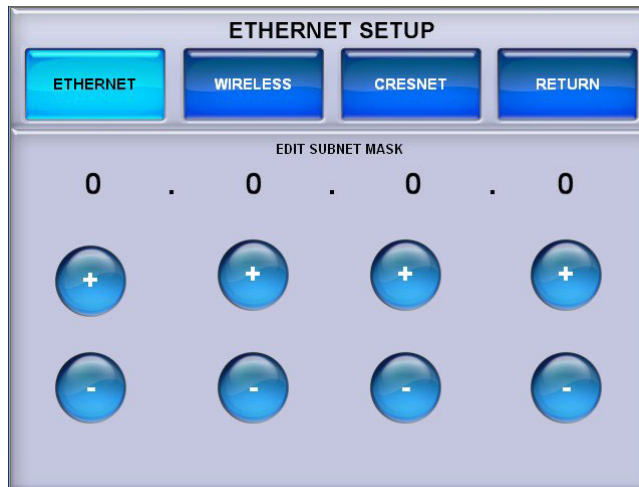
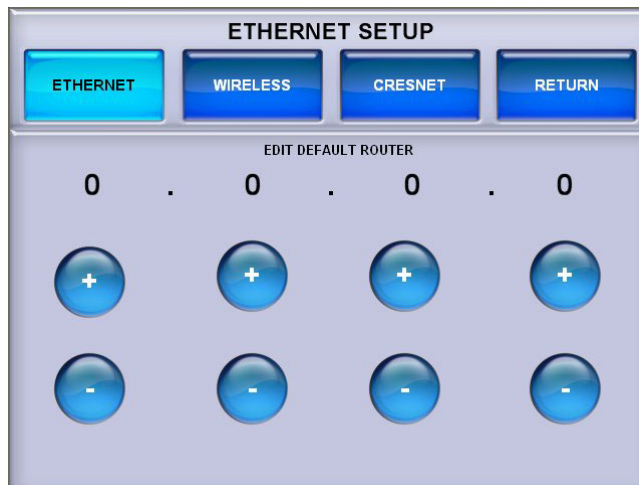
ETHERNET SETUP (EDIT SUBNET MASK Menu)*ETHERNET SETUP (EDIT DEFAULT ROUTER Menu)*

From the main ETHERNET SETUP menu, in the *Static IP Settings* section, touch **DNS Servers** to enter the STATIC DNS SETTINGS menu, as shown in the following illustration.

ETHERNET SETUP (STATIC DNS SETTINGS Menu)

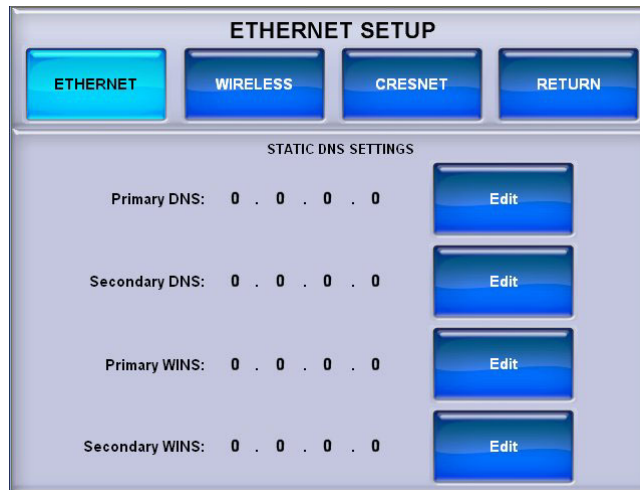

From the STATIC DNS SETTINGS menu, touch the **Edit** buttons to enter the menus that allow you to set the *Primary DNS*, *Secondary DNS*, *Primary WINS* and *Secondary WINS*, as shown in the following illustrations. + and – buttons on each menu are provided for setting the numbers. In each case, touch **RETURN** to go back to the previous menu.

ETHERNET SETUP (EDIT PRIMARY DNS Menu)

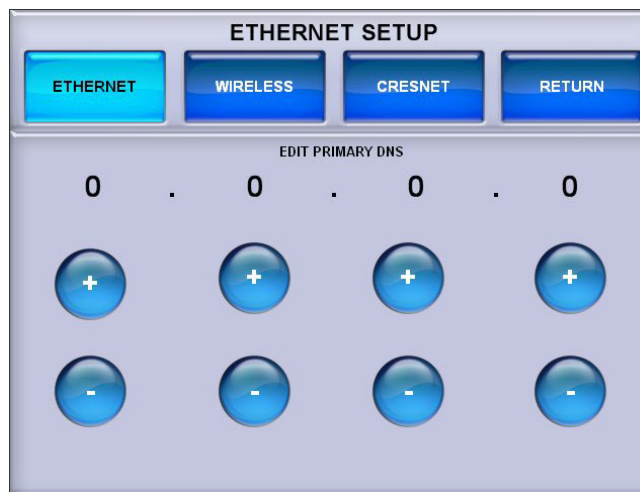

ETHERNET SETUP (EDIT SECONDARY DNS Menu)

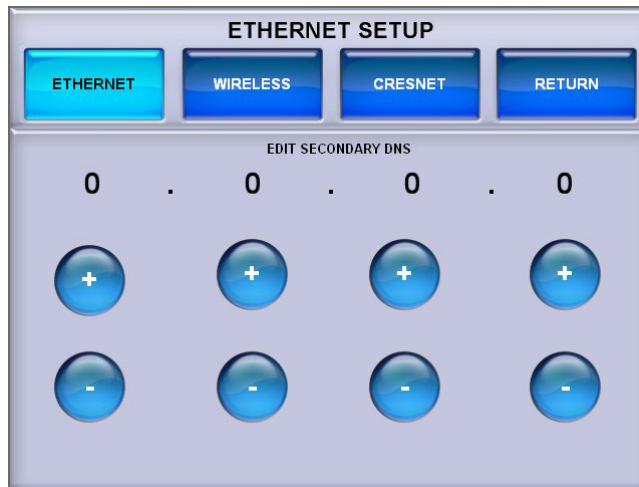

ETHERNET SETUP (EDIT PRIMARY WINS Menu)

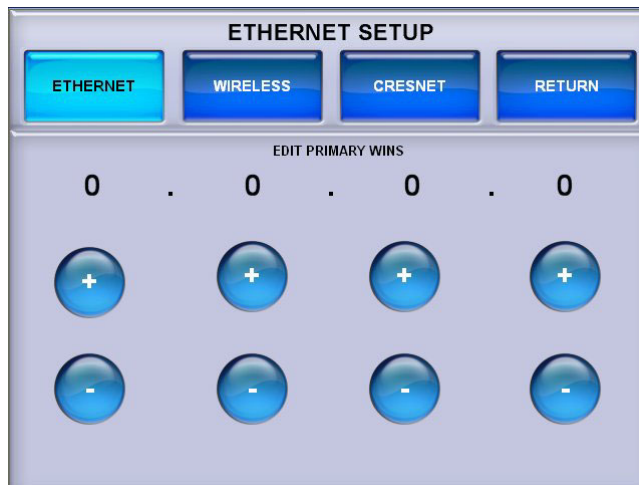

ETHERNET SETUP (EDIT SECONDARY WINS Menu)

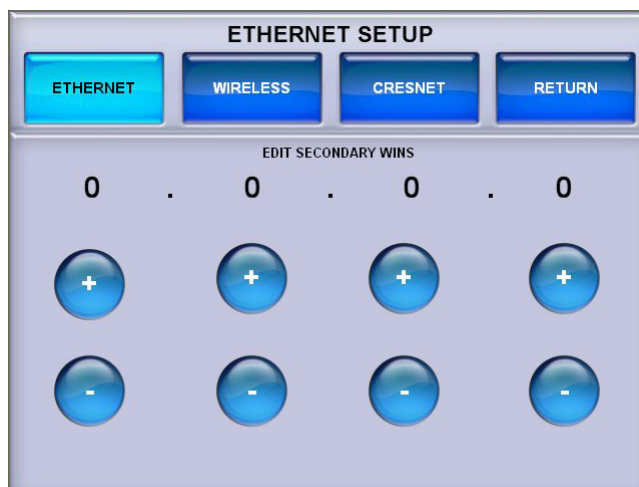

When all settings have been entered, touch **RETURN** to go back to the main ETHERNET SETUP menu and touch **Reboot required for setting to take effect. Reboot Now.**

WIRELESS

Touch **WIRELESS** to enter the WIRELESS SETUP menu.

WIRELESS SETUP Menu



The WIRELESS SETUP menu displays RF connection status, signal strength, gateway name and UID, RF channel and RF power settings. – and + controls are provided to set the *RF ID* and *IR ID*.

The **ACQUIRE START** button is used in conjunction with the **ACQUIRE** button on the CEN(I)-HPRFGW gateway (sold separately) to place the TPS-6X in *Acquire* mode. Refer to the “Operation” section of the CEN-HPRFGW High Powered RF Gateway Operations & Installation Guide (Doc. 6587) for details.

When the acquire process is complete, the menu will display an *Acquire Complete* message, as shown in the following illustration.

WIRELESS SETUP Menu (Acquire Complete)

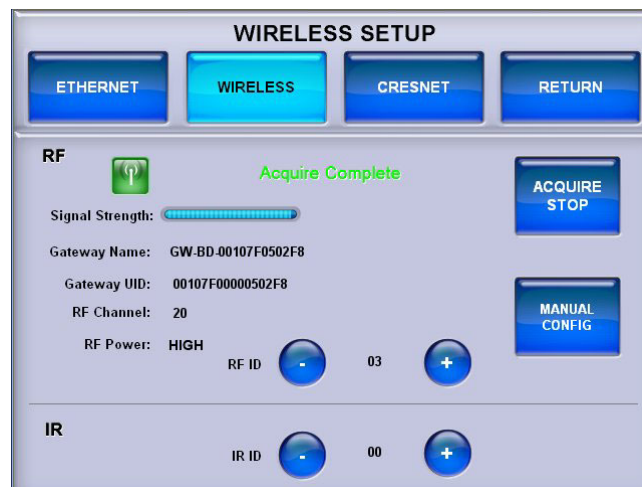

To check the quality of your link status, from the MAIN MENU, touch **Diagnostics** to open the DIAGNOSTICS menu (refer to “DIAGNOSTICS” on page 36). On the DIAGNOSTICS menu, touch **WIRELESS**, then touch **Link Quality**.

The screen will display the *Received Signal Strength at Panel* and *Received Signal Strength at Gateway* meters, as shown in the following illustration.

DIAGNOSTICS Menu Showing Wireless Link Quality

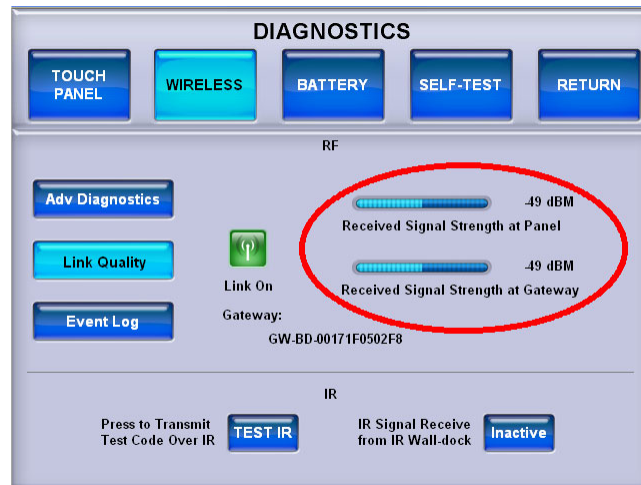

Other buttons on the DIAGNOSTICS menu should only be used under the supervision of a Crestron customer service representative during telephone support.

For more information regarding wireless setup, refer to “Appendix A: The RF Spectrum” on page 57 and “Appendix B: Optimum RF Reception Guidelines” which starts on page 58.

Touch **MANUAL CONFIG** to enter the manual configuration menu where you can change the *RF Power* and set the *RF Channel*, as shown in the following illustration. When using manual configuration, these should be selected to match the gateway prior to starting the acquire process.

WIRELESS SETUP (MANUAL CONFIG Menu)

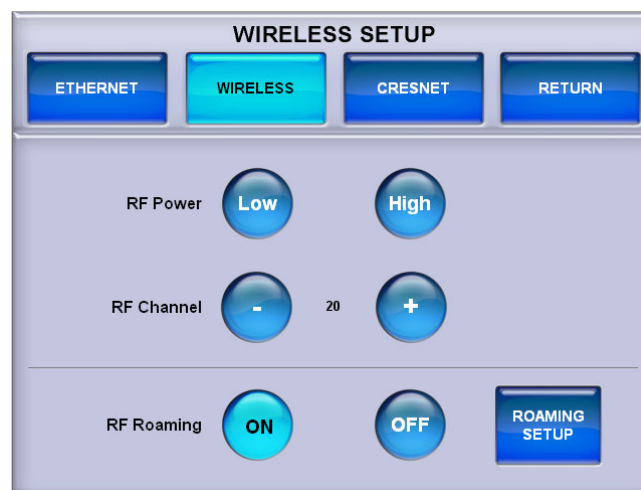

The manual configuration menu also has buttons to turn *RF Roaming* **ON** or **OFF** and for **ROAMING SETUP**.

The TPS-6X can be used with multiple CEN-HPRFGW gateways to create a wireless roaming network.

NOTE: By default, roaming is disabled in both the TPS-6X and CEN-HPRFGW and must be enabled in both devices.

On the CEN-HPRFGW, enable roaming by using the following procedure:

1. Open a text console for the gateway using the gateway's IP address.
2. Enter the command RFROAMING ON.
3. Enter the command REBOOT.

This procedure must be performed for each gateway used in the roaming setup. For more information about roaming, refer to the TPS-6X Roaming Quickstart Guide (Doc. 6799), available from the Crestron website.

To enable roaming in the TPS-6X, touch *RF Roaming* **ON**. A **ROAMING SETUP** button will appear.

When roaming is enabled, a **ROAMING SETUP** button will also appear in place of the **ACQUIRE START** button on the main WIRELESS SETUP menu.

WIRELESS SETUP Menu (Shown with Roaming Enabled)

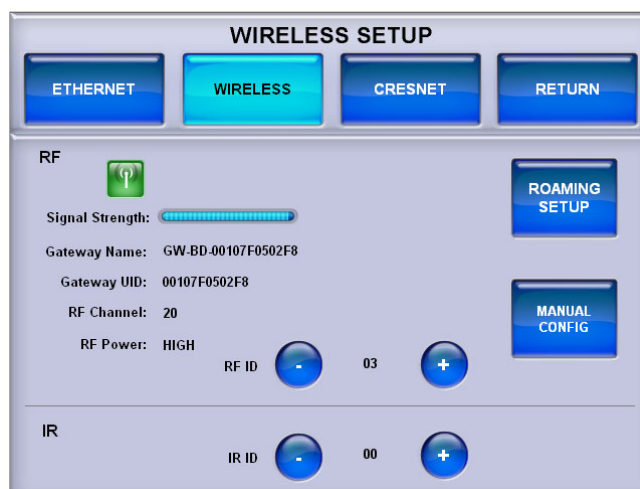

From the manual configuration menu or the main WIRELESS SETUP menu, touch **ROAMING SETUP** to enter the roaming setup menu shown on the following page.

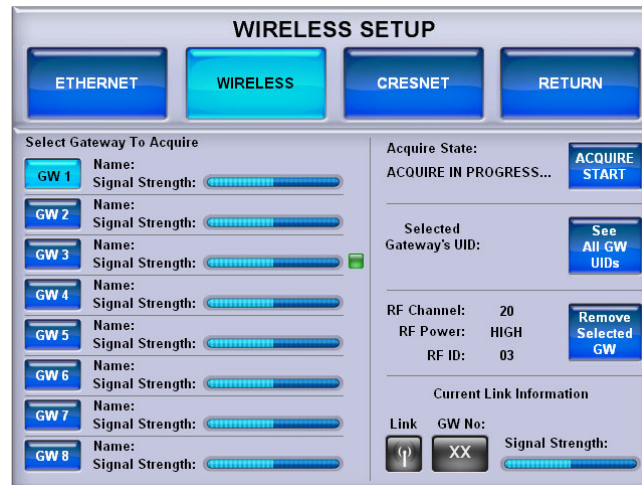
WIRELESS SETUP Menu (Shown in Roaming Setup Configuration)

Up to eight CEN-HPRFGW gateways can be acquired by a TPS-6X. To acquire multiple gateways, put all the gateways in *Acquire* mode. Then follow the steps below:

1. Select the appropriate gateway index by touching one of the buttons marked **GW 1** through **GW 8** on the left side of the roaming setup menu.
2. Touch **ACQUIRE START**. Acquire progress will be shown in the *Acquire State* section of the menu. Once the TPS-6X finds a gateway, the acquire will automatically stop.
3. Repeat steps 1 and 2 until all gateways are acquired.

If you are using multiple TPS-6X touchpanels, follow the steps above for each touchpanel.

NOTE: When multiple gateways are put in *Acquire* mode at the same time, the TPS-6X will save the first available gateway in the selected gateway index. To save gateways in a particular order on the list, put only one gateway in *Acquire* mode at a time and perform the acquire process, selecting the required gateway index. Gateways which are already acquired, will not be acquired again, unless first removed from the list, as shown on the following page.

For each acquired gateway in the list, the name and signal strength is shown on the roaming setup menu. A small green indicator will be displayed next to the signal strength meter of the gateway to which the panel is currently connected.

Selected Gateway's UID, shown at the right side of the screen, indicates the currently selected gateway's UID.

Touch **See All GW UIDs** to see the UIDs of all acquired gateways at once. The screen will look like the illustration on the following page.

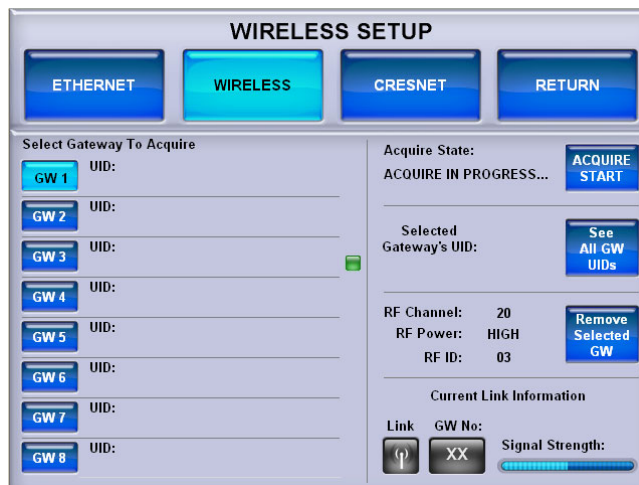
WIRELESS SETUP Menu (Showing All Gateway UIDs)

Touch **See All GW UIDs** again to turn off the UID display and return to the screen shown on page 30.

To remove an acquired gateway from the list, select the appropriate index for that gateway (**GW 1** through **GW 8**) and touch **Remove Selected GW**. A **CONFIRM GATEWAY REMOVE** message will appear, as shown in the illustration that follows.

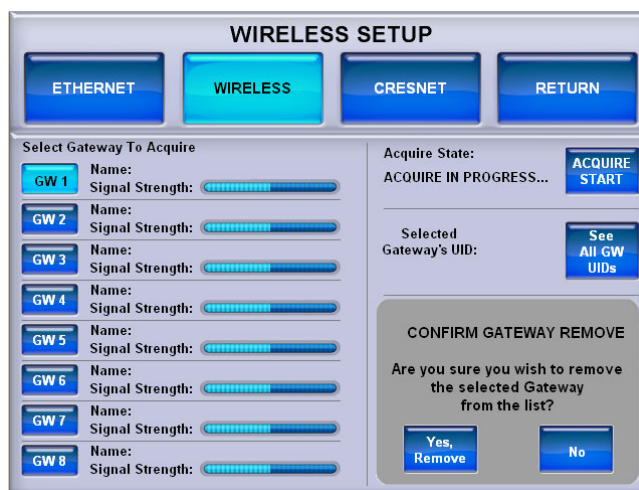
WIRELESS SETUP Menu (Showing CONFIRM GATEWAY REMOVE Message)

Touch **Yes, Remove** to remove the gateway or **No** to cancel.

The *Current Link Information* section of the screen (refer to illustration at the top of this page) shows the following:

1. The *Link* status indicator light shows if the TPS-6X is currently connected to a gateway.
2. The *GW No* indicator shows the index of the gateway in the list, to which the TPS-6X is currently connected.
3. The *Signal Strength* meter shows the quality of the signal from the currently connected gateway.

Touch **RETURN** to go back to the main WIRELESS SETUP menu.

CRESNET

Touch **CRESNET** to enter the CRESNET SETUP menu.

CRESNET SETUP Menu

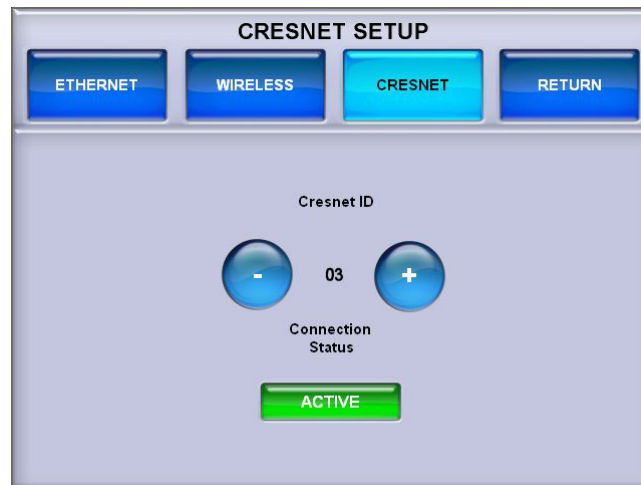

The CRENSET SETUP menu has – and + controls to set the *Cresnet ID* and a *Connection Status* indicator to show when the Cresnet connection is active.

Touch **RETURN** to go back to the main COMMUNICATIONS menu. After communications parameters have been set, touch **RETURN** to go back to the SETUP MODE menu or MAIN MENU.

TOUCH PANEL

From the SETUP MODE menu, touch the **TOUCH PANEL** button to enter the TOUCHPANEL menu.

TOUCHPANEL Menu

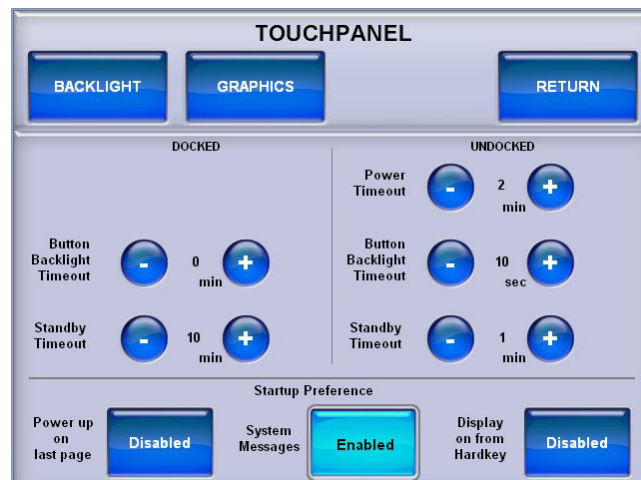

The TOUCHPANEL menu offers access to BACKLIGHT SETUP and GRAPHICS SETUP menus as well as a series of – and + controls to set the *Power Timeout* (when the touchpanel is undocked), *Button Backlight Timeout* and *Standby Timeout*. Buttons are also provided to enable/disable *Power up on last page*, which will cause the touchpanel to boot up to the last page it was on before shut down, *System*

Messages, which will display gateway or control system disconnect warnings and *Display on from Hardkey*, which causes the display to turn on along with the touchpanel at the press of any key on the front of the touchpanel.

NOTE: Disabling *System Messages* will not prevent a warning message in the event of a low battery condition.

BACKLIGHT

From the TOUCHPANEL menu, touch **BACKLIGHT** to enter the BACKLIGHT SETUP menu, shown in the following illustration.

BACKLIGHT SETUP Menu

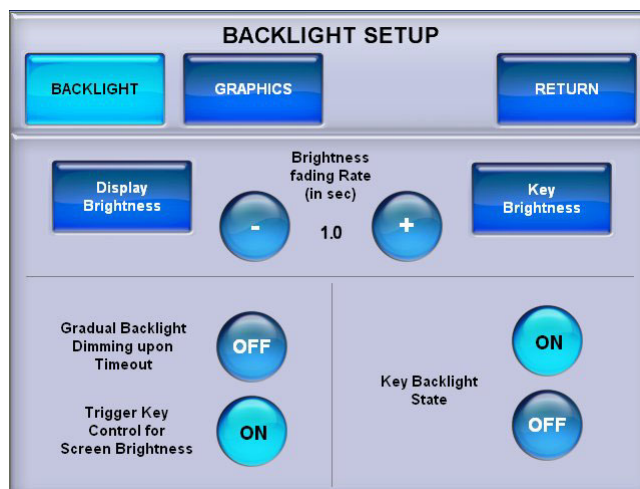

The BACKLIGHT SETUP menu offers access to the DISPLAY BRIGHTNESS and KEY BACKLIGHT BRIGHTNESS menus as well as – and + controls to set the *Brightness fading Rate* (i.e. how fast the screen brightness changes when the **HIGH**, **MEDIUM** or **LOW** buttons are touched or the right trigger key is used to control screen brightness). There are also **ON/OFF** controls for *Gradual Backlight Dimming upon Timeout*, *Trigger Key Control for Screen Brightness* and *Key Backlight State*.

Gradual Backlight Dimming upon Timeout sets the screen to fade to black when **ON** or to simply shut off when **OFF**. When set to **ON**, the fade rate is five seconds.

Trigger Key Control for Screen Brightness enables brightness toggling with the right trigger key (on top of the touchpanel). When **ON**, the right trigger key will toggle display brightness between high, medium, low and standby.

NOTE: The right trigger key can toggle screen brightness when the TPS-6X is displaying a project. It will not toggle screen brightness in the setup menus.

Key Backlight State turns the backlighting for the front panel keys **ON** or **OFF**.

Touch **Display Brightness** to enter the DISPLAY BRIGHTNESS menu, shown in the illustration on the following page.

DISPLAY BRIGHTNESS Menu



The DISPLAY BRIGHTNESS menu provides – and + controls to adjust *Current Display Brightness*, *High Backlight Level*, *Medium Backlight Level* and *Low Backlight Level*. These last three are the brightness levels the display will be set to as the right trigger key (on top of the touchpanel) is used to toggle between high, medium, and low screen brightness, provided *Trigger Key Control for Screen Brightness* is set to **ON** in the BACKLIGHT SETUP menu.

The *Press To Trigger Level Now* buttons allow for immediate setting of screen brightness level to **HIGH**, **MEDIUM** or **LOW**.

Touch **RETURN** to go back to the BACKLIGHT SETUP menu.

From the BACKLIGHT SETUP menu, touch **Key Brightness** to enter the KEY BACKLIGHT BRIGHTNESS menu, shown in the following illustration.

KEY BACKLIGHT BRIGHTNESS Menu



The KEY BACKLIGHT BRIGHTNESS menu provides – and + controls to adjust *Current Key Brightness*, *High Backlight Level*, *Medium Backlight Level* and *Low Backlight Level*.

The *Press To Trigger Level Now* buttons allow for immediate setting of key brightness level to **HIGH**, **MEDIUM** or **LOW**.

Touch **RETURN** to go back to the BACKLIGHT SETUP menu.

Touch **RETURN** again to go back to the TOUCHPANEL menu or touch **GRAPHICS** to enter the GRAPHICS SETUP menu, shown in the following illustration.

GRAPHICS

GRAPHICS SETUP Menu

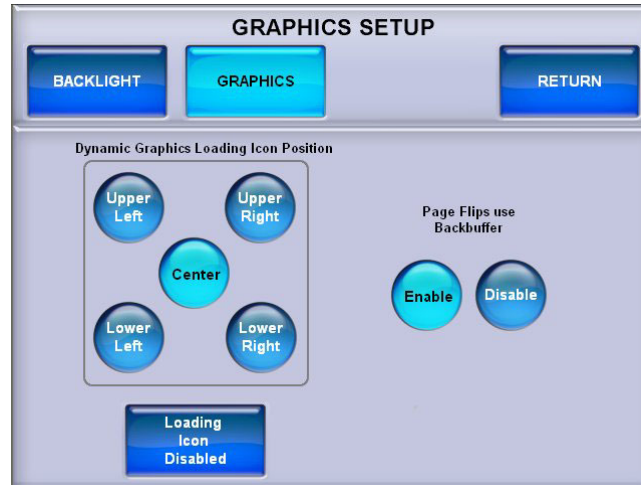

The GRAPHICS SETUP menu provides controls to set the *Dynamic Graphics Loading Icon Position* as well as a button to disable the loading icon(s), depending on user preference.

There are also *Page Flips use Backbuffer* **Enable** and **Disable** buttons. When enabled, new pages are drawn in the backbuffer and displayed when fully drawn. When disabled, new pages will be drawn on the screen from top to bottom.

Press **RETURN** to go back to the TOUCHPANEL menu. After touchpanel parameters have been set, touch **RETURN** to go back to the SETUP MODE menu or the MAIN MENU.

DIAGNOSTICS

The **Diagnostics** button on the MAIN MENU should only be used under the supervision of a Crestron customer service representative during telephone support. Many options available on the DIAGNOSTICS menu, shown in the following illustration, are numeric in nature and their interpretation is beyond the scope of this manual.

DIAGNOSTICS Menu

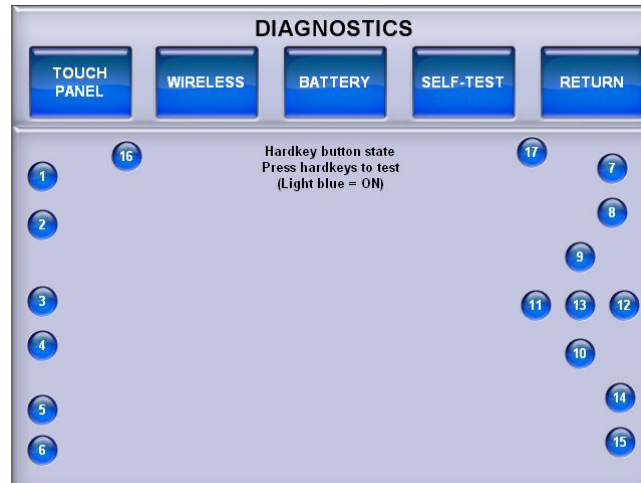

Hardware Hookup

The TPS-6X comes in a soft felt bag to protect it during shipping.

The TPS-6X does not require any connections for wireless operation but does need to be acquired by a CEN(I)-HPRFGW gateway (sold separately). Refer to “WIRELESS” which starts on page 27 and to the “Operation” section of the latest version of the CEN-HPRFGW High Powered RF Gateway Operations & Installation Guide (Doc. 6587) for details.

For Cresnet or Ethernet connection or to upgrade touchpanel firmware, the TPS-6X must be placed on the TPS-6X-DS (or with TPS-6XNL models, the TPS-6XNL-DS) Docking Station, which must be connected to the TPS-6X IMCW Interface Module (both included), which in turn must be connected to a control system via Cresnet or Ethernet. For details, refer to the latest version of the TPS-6X-DS & TPS-6XNL-DS Operations Guide (Doc. 6876) and the TPS-6X-IMCW Installation Guide (Doc. 6874).

Make the necessary connections as called out in the illustrations on the following pages. Refer to “Network Wiring” on page 12 before attaching the 4-position terminal block connector. Apply power after all connections have been made.

When making connections to the TPS-6X-IMCW, use Crestron power supplies for Crestron equipment.

To mount the TPS-6X, the touchpanel must first be positioned onto the docking station at a slight angle to latch the top portion of the docking station onto the touchpanel. Magnets on the TPS-6X-DS (and TPS-6XNL-DS) attach to metal plates installed on the TPS-6X to secure the touchpanel in place (refer to the following illustration).

Touchpanel Mounting

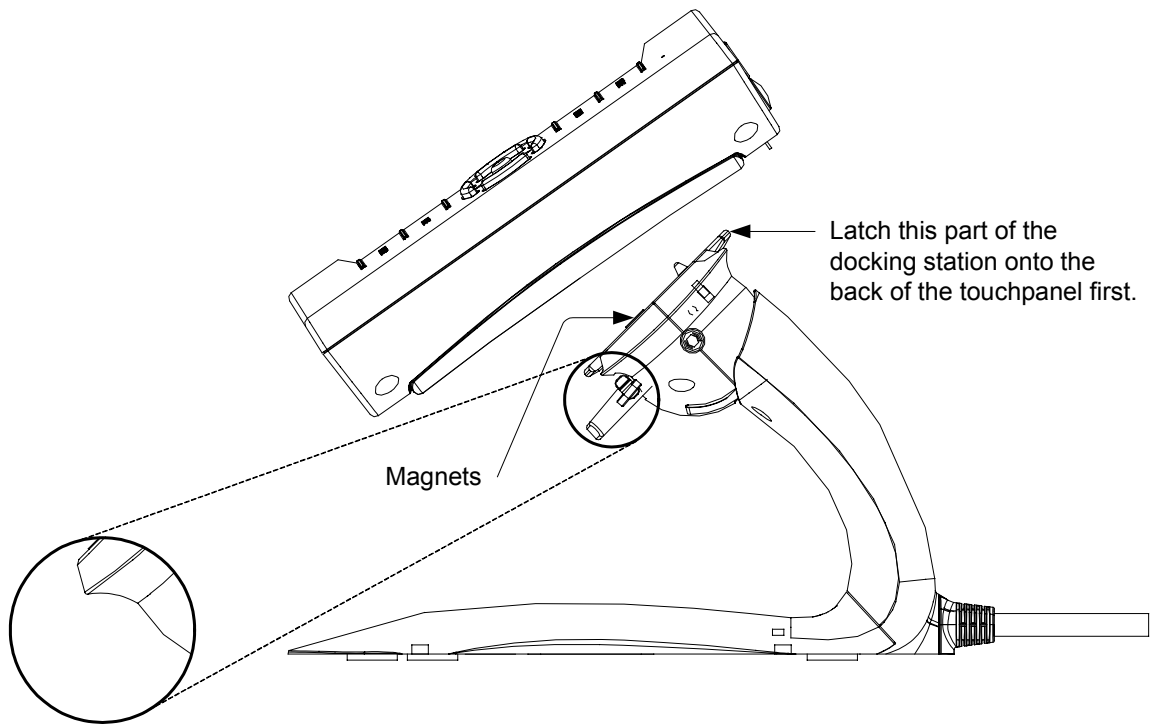
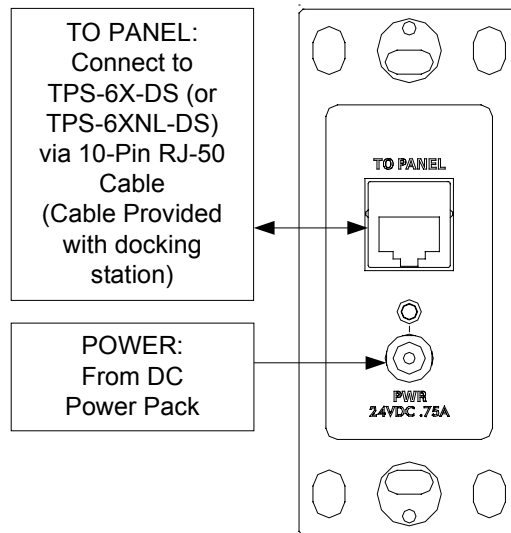
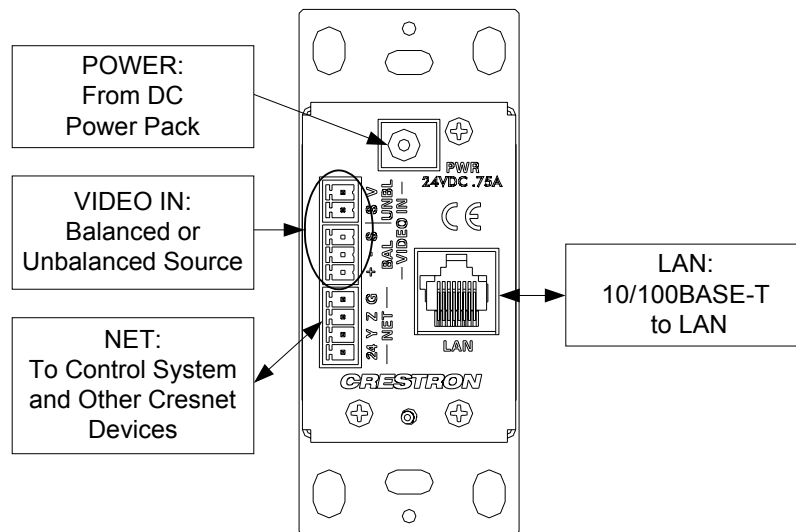

Image in circle above, shows TPS-6XNL-DS, with no locking mechanism.

Hardware Connections for the TPS-6X-IMCW (Front)



Hardware Connections for the TPS-6X-IMCW (Rear)

NOTE: Ensure the TPS-6X-IMCW is properly grounded.

NOTE: The TPS-6X-IMCW can be powered via the **24 VDC** jack on either the front or the back of the unit if the **NET** port is not being used to power the module.

Recommended Cleaning

Touchscreen

Keep the surface of the touchscreen free of dirt, dust or other materials that could degrade optical properties. Long-term contact with abrasive materials can scratch the surface, which may detrimentally affect image quality.

For best cleaning results, use a clean, damp, non-abrasive cloth with any commercially available non-ammonia glass cleaner. Bezels may not provide a complete watertight seal. Therefore, apply cleaning solution to the cloth rather than the surface of the touchscreen. Wipe touchscreen clean and avoid getting moisture beneath the bezels.

CAUTION: Do not apply excessive pressure to the touchscreen display during handling. Doing so can crack the screen and damage the touchpanel.

Enclosure

The soft felt bag the TPS-6X came shipped in can be used to clean the bezel and the rest of the touchpanel enclosure.

Programming Software

Have a question or comment about Crestron software?

Answers to frequently asked questions (FAQs) can be viewed in the Online Help section of the Crestron website. To post a question or view questions you have submitted to Crestron's True Blue Support, log in at <http://support.crestron.com>. First-time users will need to establish a user account.

Earliest Version Software Requirements for the PC

NOTE: Crestron recommends that you use the latest software to take advantage of the most recently released features. The latest software is available from the Crestron website.

Crestron has developed an assortment of Windows®-based software tools to develop a controlled system. For the minimum recommended software versions, visit the Version Tracker page of the Crestron website (www.crestron.com/versiontracker).

Programming with Crestron SystemBuilder

Crestron SystemBuilder is the easiest method of programming but does not offer as much flexibility as SIMPL Windows. For additional details, download SystemBuilder from the Crestron website and examine the extensive help file.

Programming with SIMPL Windows

NOTE: While SIMPL Windows can be used to program the TPS-6X, it is recommended to use SystemBuilder for configuring a system.

SIMPL Windows is Crestron's premier software for programming Crestron control systems. It is organized into two separate but equally important "Managers".

Configuration Manager

Configuration Manager is the view where programmers "build" a Crestron control system by selecting hardware from the *Device Library*.

1. The TPS-6X must first be incorporated into the system.
 - a. To incorporate the TPS-6X (Cresnet) into the system, drag the TPS-6X from the Touchpanels | Touchpanels (Cresnet) folder of the *Device Library* and drop it in the *System Views*.

Locating the TPS-6X (Cresnet) in the Device Library

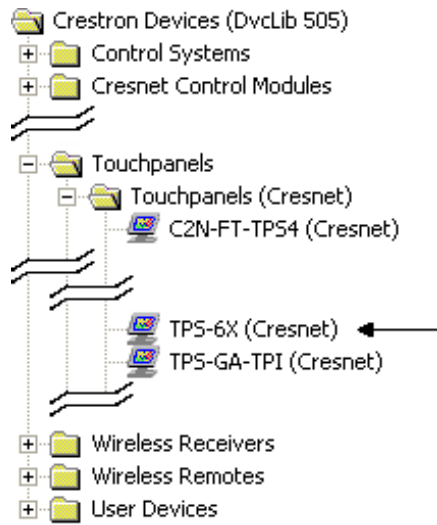

- b. To incorporate the TPS-6X (Ethernet) into the system, drag the TPS-6X from the Touchpanels | Touchpanels (Ethernet) folder of the *Device Library* and drop it in the *System Views*.

Locating the TPS-6X (Ethernet) in the Device Library

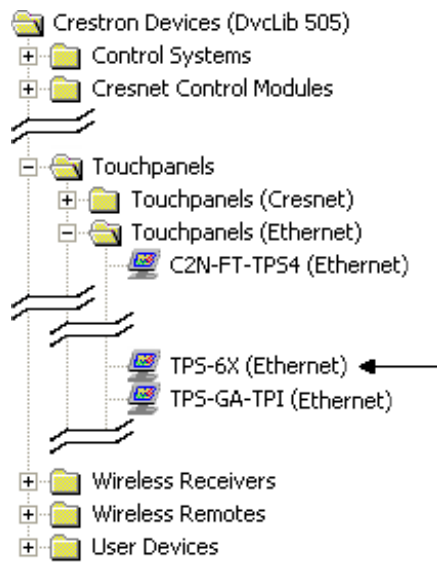

- c. To incorporate the TPS-6X (RF) into the system, drag the TPS-6X from the Touchpanels | Touchpanels (Wireless Two-Way) folder of the *Device Library* and drop it in the *System Views*.

Locating the TPS-6X (RF) in the Device Library

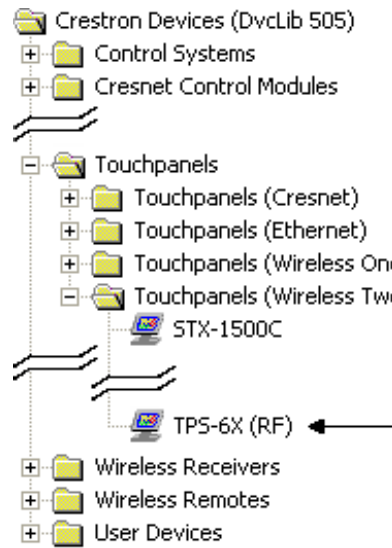

- d. To incorporate the TPS-6X (IR) into the system, drag the TPS-6X from the Touchpanels | Touchpanels (Wireless One-Way) folder of the Device Library and drop it in the System Views.

Locating the TPS-6X (IR) in the Device Library

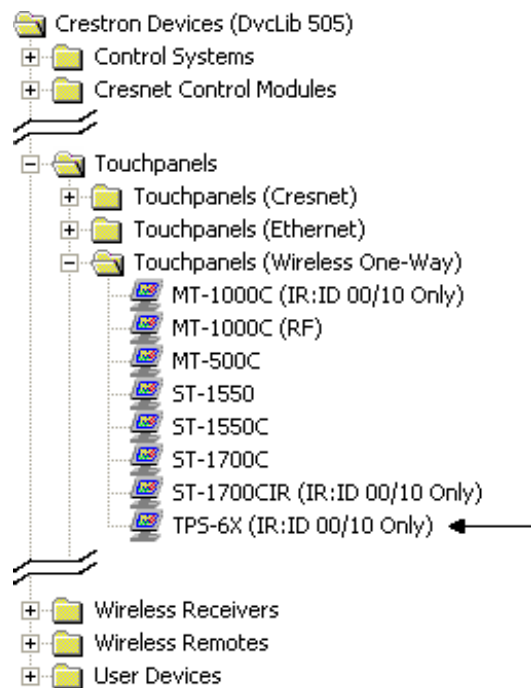

- 2. The system tree of the control system displays the device in the appropriate slot(s) with a default Net ID, IP ID, RF ID or IR ID as shown in the following illustrations.

C2Net Device, Slot 8 and 9 (Net ID and IP ID)

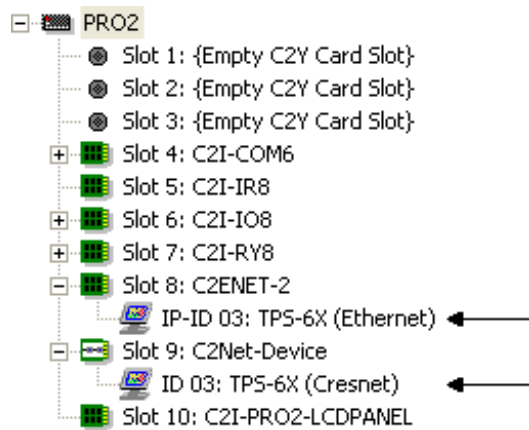

C2Net Device, Slot 8 and 9 (RF ID)

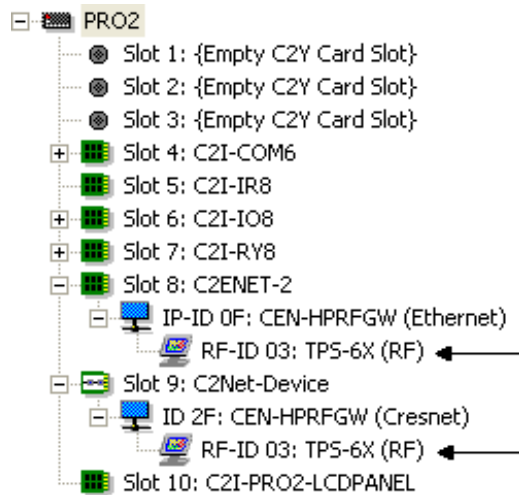

C2Net Device, Slot 9 (IR ID)

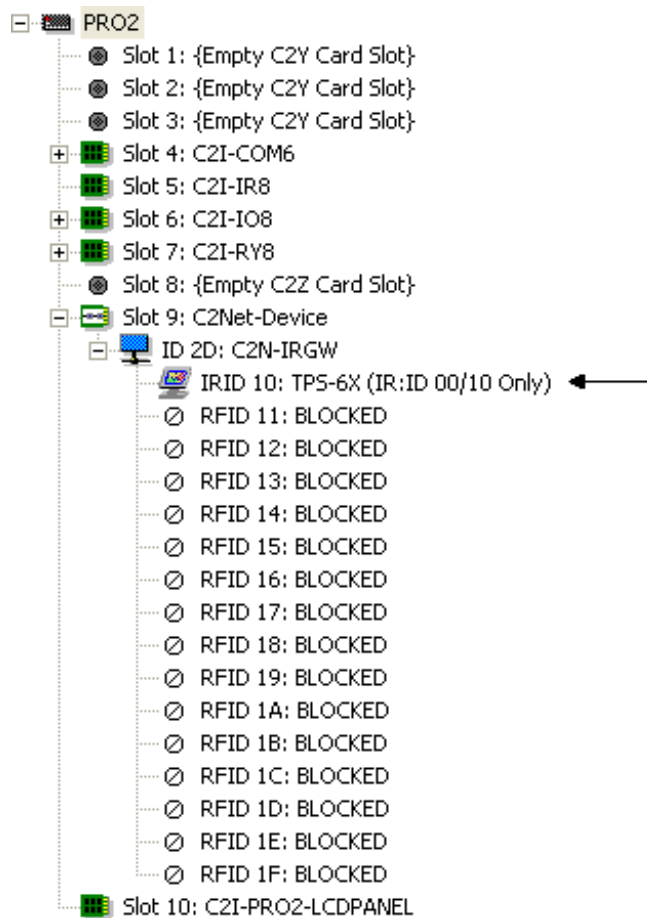

3. Additional TPS-6X devices are assigned different Net ID, IP ID, RF ID or IR ID numbers as they are added.
4. If necessary, double click a device to open the “Device Settings” window and change the Net ID, IP ID, RF ID or IR ID, as shown in the following figure(s).

“TPS-6X (Cresnet) Device Settings” Window

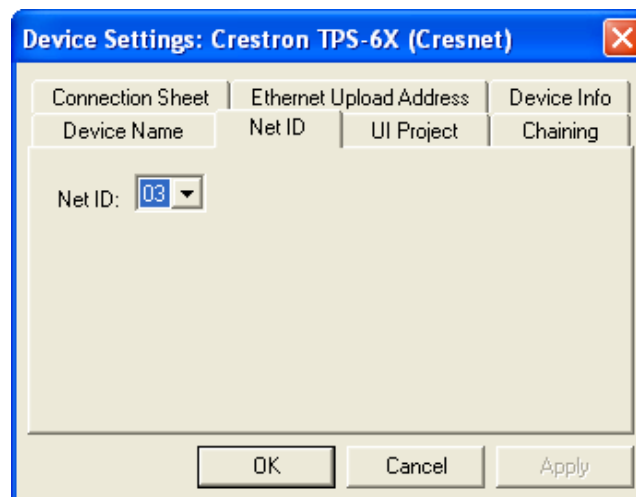

“TPS-6X (Ethernet) Device Settings” Window

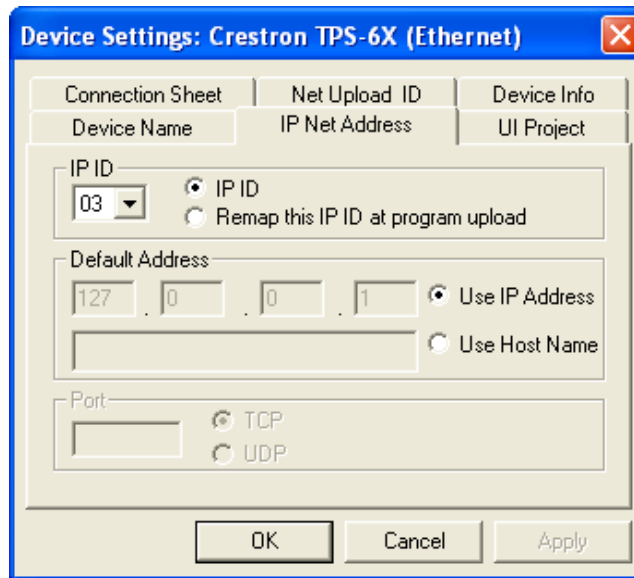

“TPS-6X (RF) Device Settings” Window

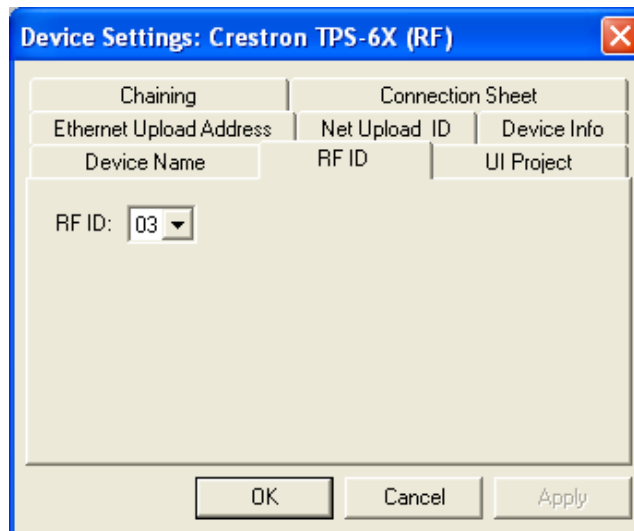

“TPS-6X (IR) Device Settings” Window

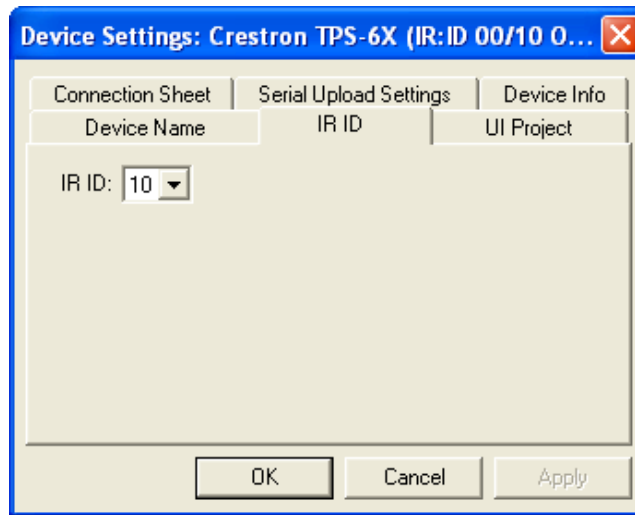

- The ID code specified in the SIMPL Windows program must match the Net ID, IP ID, RF ID or IR ID of each unit. Refer to “Identity Code” which starts on page 12.

Program Manager

Program Manager is the view where programmers “program” a Crestron control system by assigning signals to symbols.

The symbol can be viewed by double clicking on the icon or dragging it into *Detail View*. Each signal in the symbol is described in the SIMPL Windows help file (**F1**).

Programming with VisionTools Pro-e

Touchpanel screens should be created in VisionTools Pro-e (VT Pro-e) to allow switching of source signals to desired outputs as well as selection of the system mode. There are no special programming requirements to use the functions of the TPS-6X in a room control system.

RF or IR Operation

Using VT Pro-e, the TPS-6X can be set to communicate via either RF or IR. This selection is made using the *Panel Type* drop down menu at the time a new TPS-6X project is created, as shown in the following illustration.

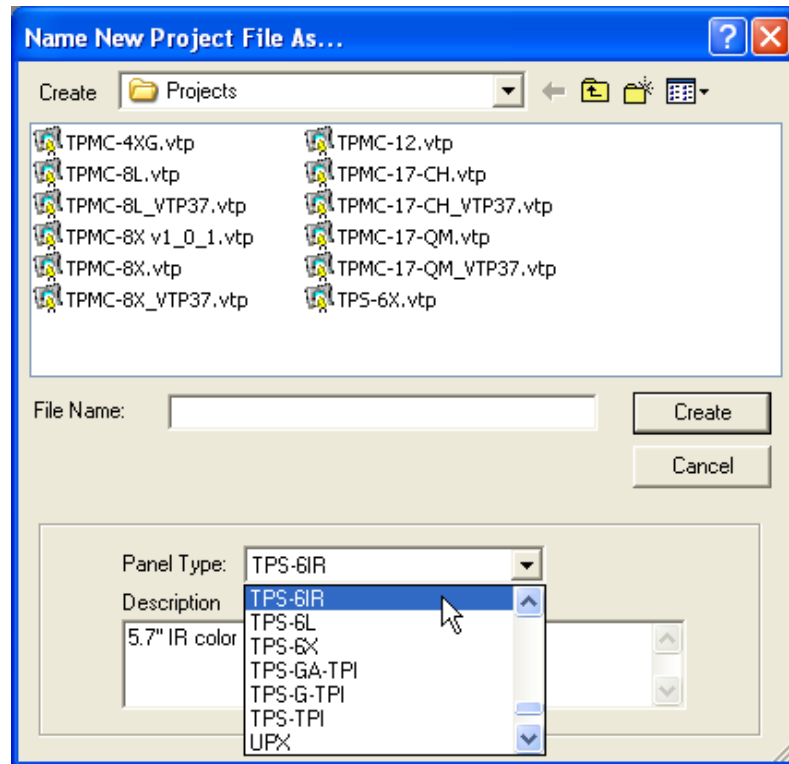
VT Pro-e New Project Window (Showing Selection of Panel Type)

The **TPS-6X** project type, when loaded, will place the TPS-6X into an RF only mode. The **TPS-6IR** project type will place the TPS-6X into an IR only mode.

When in IR only mode, the RF is turned off and will not function. In this mode, there is no RF radiation present.

You must set the IR ID information to match your program. This is done on the WIRELESS SETUP menu (refer to “WIRELESS” which starts on page 27) and in the SIMPL Windows program (refer to “Programming with SIMPL Windows” which starts on page 39).

Multi-Mode Objects

Multi-mode objects offer high-performance programming!

The single most advanced VT Pro-e high performance programming technique involving the TPS-6X is the concept of multi-mode objects. A multi-mode object (i.e. button, legend, etc.) is an object drawn on a VisionTools Pro-e page that can have one or more active and inactive visible settings (*modes*).

For examples, refer to www.crestron.com/exampleprograms and search for multi-mode object examples. This file contains the VT Pro-e touchpanel files and SIMPL Windows files that illustrate the high-performance capabilities of multi-mode objects.

Bit Depth and File Size

A balance of performance and quality can be achieved by using VT Pro-e to configure the size of graphics in a project. Read this section to learn about bit depth and how to maximize the quality and performance of a TPS-6X project.

Bit depth refers to the number of memory bits used to store color data for each pixel in a raster image. A touchpanel raster image consists of a rectangular grid of picture

elements (pixels). Each pixel uses the same amount of memory to store its color data. The amount of memory is called the bit depth of the image.

Greater bit depths are required to represent finer gradations of color. Increasing bit depth necessarily increases file size. A black and white drawing requires only one bit per pixel to store all the available color information. Using a 32-bit per pixel bit depth for a black and white image increases the file size 32 times without adding anything to the black and white image quality.

In an 8-bit per pixel system, the associated 8-bits of video memory for every screen pixel contain a value referring to a location in an 8-bit color table. In this way, any one of the specific 256 color table locations is assigned to a pixel.

A 16-bit highcolor system is considered sufficient to provide life-like colors. It is encoded using 5-bits to represent red, 5-bits to represent blue and (since the human eye is more sensitive to the color green) 6-bits to represent 64 levels of green. These can therefore be combined to provide 65,536 mixed colors ($32 \times 32 \times 64 = 65,536$).

In a 24-bit graphics display, the video memory allocates 24 bits for each pixel on the screen enabling each pixel to take on any one of a possible 16.7 million colors. Each 24-bit value is composed of 8-bits for red, 8-bits for green and 8-bits for blue. These triplets of 8-bit values are also referred to as the red, green and blue color planes. A 24-bit image is actually composed of three component images which combine to create the truecolor picture. The reason this is called truecolor is that this is near the maximum number of colors the human eye is able to detect.

Truecolor images are sometimes represented by a 32-bit value. The extra 8-bits do not enhance the precision of the color representation but act as an alpha channel that represents pixel translucence. 32-bit truecolor has become popular on the computer desktop to provide effects such as translucent windows, fading menus and shadows.

In graphics intensive applications such as touchpanels, raising or lowering the color depth of the displayed graphics can achieve a balance of performance and quality. Lower color depths do not require as much frame buffer memory or display bandwidth, allowing them to be generated and displayed more quickly. Increasing color depth results in higher color quality at the expense of display speed and responsiveness. By using mostly 8-bit or 16-bit graphics and holding 32-bit graphics to a minimum (e.g. for a family photo, etc.), you can create a sophisticated project that will fit in the memory space provided and have the touchpanel remain very responsive.

Relationship of Bits to Colors

NUMBER OF BITS	NUMBER OF COLORS
1 bit	Black and White
2 bits	4 Colors
4 bits	16 Colors
8 bits	256 Colors
16 bits	65,536 Colors (Highcolor)
24 bits	16.7 million Colors (Truecolor)
32 bits	16.7 million Colors plus Transparency

When creating a VT Pro-e project you can elect to compress and reduce the image size in the “Page Properties” window for the entire page and/or perform the same function of reducing the image size using the “Image Properties” window. A reduction in image size will save a considerable amount of memory space for your project.

In VT Pro-e, the **Compress** checkbox permits the image to be compressed when compiling. This conversion may cause the loss of some subtle shading. To compensate for this, use the dithering to simulate the original shading. Check your image with each of the available dithering types to determine which will deliver the best quality image.

Dithering type selection can be accessed from the “Page Properties” or “Image Properties” windows in VT-Pro-e. Refer to the following illustrations.

VT Pro-e “Page Properties” Window – Bit Depth Selection

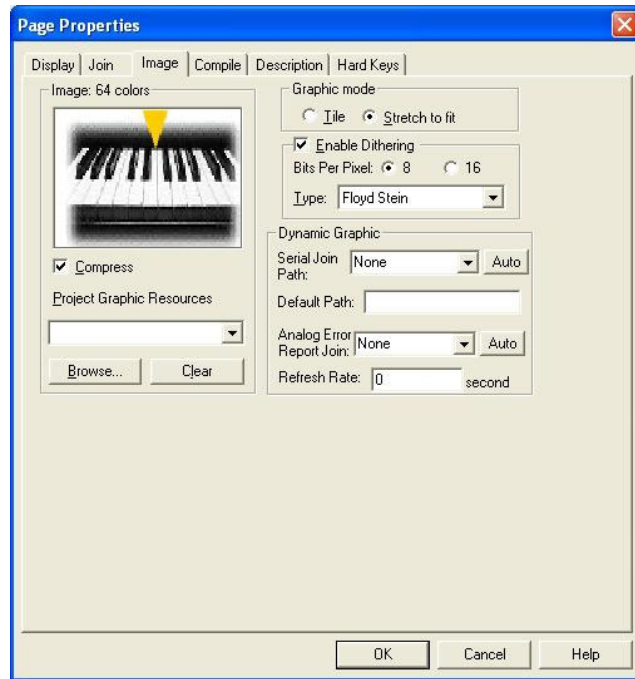

VT Pro-e “Image Properties” Window – Bit Depth Selection

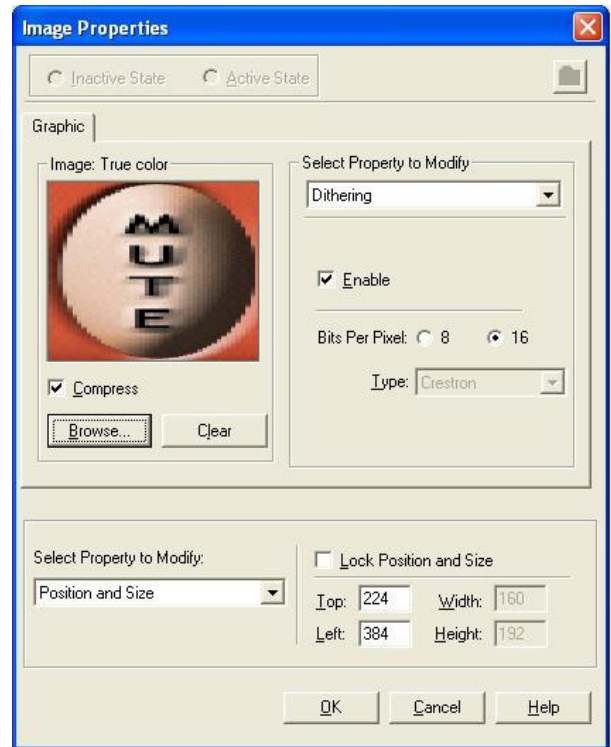

Pushbutton Programming

Any of the buttons can be programmed to access any frequently used command. Each button has a permanently fixed digital join number. Refer to the following illustration for their assigned join numbers. A description for each button signal is described in the SIMPL Windows help file (F1).

Pushbutton Layout and Join Number Assignment

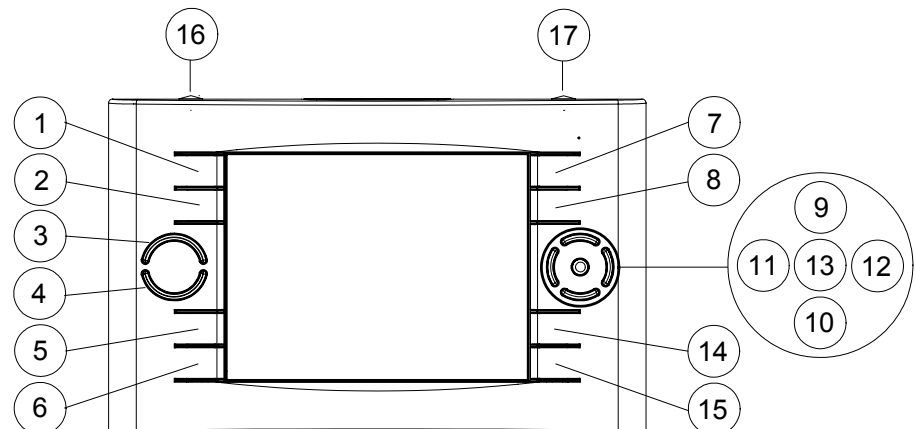

NOTE: Join numbers 16 and 17 are fixed for the two “trigger” keys, the top-mounted pushbuttons on the TPS-6X. The left trigger key toggles power when the unit is undocked and initiates *Sleep* mode when docked. In addition, when held for five seconds, it initiates a touchpanel reset. The right trigger key toggles screen brightness, unless it is disabled with the on-screen button in the BACKLIGHT SETUP menu (refer to “BACKLIGHT” which starts on page 33).

While both of these join numbers can be programmed to perform other functions, their main functions as outlined above will still be in effect, i.e. each button will perform both its default and its newly programmed operation.

MultiByte International Characters

Most languages use a single byte of eight bits to represent a character, e.g. English, French, German, Hebrew, Russian, Thai, etc.

Multibyte character fonts require more than the usual eight bits to specify a character. This occurs when a language has more than 256 characters (2^8) in a font. For example, Chinese fonts contain several thousand characters. Other multibyte languages include Japanese and Korean.

There are two separate applications with multibyte characters – static text on buttons and indirect text on buttons. No Isys touchpanel firmware changes are required in either case.

Indirect text on a button is entered in VT Pro-e and the actual string to be displayed is entered in SIMPL Windows. As of this publication date only completely single byte or completely multibyte strings may be entered or they will not be compiled correctly in SIMPL Windows. In other words, you cannot enter Chinese characters interspersed with numbers. You can enter Chinese characters or numbers in separate strings or you can pad each number with “\x00” to make it multibyte and then combine it with Chinese characters in the same string.

Of course, you can always use the workaround of showing a graphic that displays the string but it is not dynamic. To compile and use multibyte characters it is essential that the operating system understand the language. Windows XP, Vista and 7 are available in many international languages and add-on software is available for other versions of Windows.

Uploading and Upgrading

Crestron recommends using the latest programming software and that each device contains the latest firmware to take advantage of the most recently released features. However, before attempting to upload or upgrade it is necessary to establish communication. Once communication has been established, files (for example, programs, projects or firmware) can be transferred to the control system (and/or device). Finally, program checks can be performed (such as changing the device ID or creating an IP table) to ensure proper functioning.

Establishing Communication

Use Crestron Toolbox for communicating with the TPS-6X; refer to the Crestron Toolbox help file for details. There are two methods of communication.

Indirect

Indirect Communication

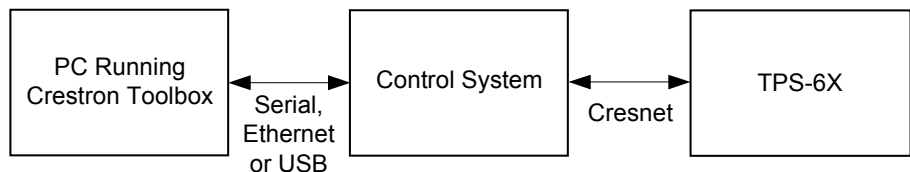

TPS-6X connects to control system via Cresnet:

1. Establish communication between the PC and the control system as described in the latest version of the 2-Series Control Systems Reference Guide (Doc. 6256).
2. Use the Address Book in Crestron Toolbox to create an entry for the TPS-6X using the expected communication protocol (Indirect). Select the Cresnet ID of the TPS-6X and the address book entry of the control system that is connected to the TPS-6X.
3. Display the TPS-6X's "System Info" window (click the  icon); communications are confirmed when the device information is displayed.

TCP/IP

Ethernet Communication

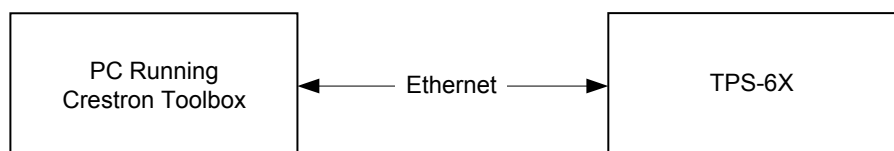

The TPS-6X connects to PC via Ethernet:

1. Enter the IP address, IP mask and default router of the TPS-6X via the Crestron Toolbox (**Functions | Ethernet Addressing**); otherwise enable DHCP.

NOTE: Use the Device Discovery Tool in Crestron Toolbox to detect all Ethernet devices on the network and their IP configuration. The tool is available in Toolbox version 1.15.143 or later.

2. Confirm Ethernet connections between TPS-6X and PC. If connecting through a hub or router, use CAT5 straight through cables with 8-pin RJ-45 connectors. Alternatively, use a CAT5 crossover cable to connect the two LAN ports directly without using a hub or router.
3. Use the Address Book in Crestron Toolbox to create an entry for the TPS-6X with the TPS-6X's TCP/IP communication parameters.
4. Display the "System Info" window (click the  icon) and select the TPS-6X entry.

Programs, Projects and Firmware

Program, project or firmware files may be distributed from programmers to installers or from Crestron to dealers. Firmware upgrades are available from the Crestron website as new features are developed after product releases. One has the option to upload programs and projects via the programming software or to upload and upgrade via the Crestron Toolbox. For details on uploading and upgrading, refer to the SIMPL Windows help file, VisionTools Pro-e help file or the Crestron Toolbox help file.

CAUTION: Crestron recommends having the TPS-6X docked and powered when loading projects or upgrading firmware.

SIMPL Windows

If a SIMPL Windows program is provided, it can be uploaded to the control system using SIMPL Windows or Crestron Toolbox.

VisionTools Pro-e

Upload the VisionTools Pro-e file to the touchpanel using VisionTools Pro-e or Crestron Toolbox.

Firmware

Check the Crestron website to find the latest firmware. (New users may be required to register to obtain access to certain areas of the site, including the FTP site.)

Upgrade TPS-6X firmware via Crestron Toolbox.

1. Establish communication with the TPS-6X and display the "System Info" window.
2. Select **Functions | Firmware...** to upgrade the TPS-6X firmware.

Program Checks

Actions that can be performed on the TPS-6X vary depending on whether it is connected via Cresnet or Ethernet.

Cresnet Connections

For Cresnet connections, using Crestron Toolbox, display the network device tree (**Tools | Network Device Tree**) to show all network devices connected to the control system. Right-click on the TPS-6X to display actions that can be performed on the TPS-6X.

Ethernet Connections

For Ethernet connections, display the "System Info" window (click the  icon) and select the **Functions** menu to display actions that can be performed on the TPS-6X.

Be sure to use the internal setup menu (refer to "COMM" which starts on page 19) or Crestron Toolbox to create the TPS-6X IP table. In Toolbox:

1. Select **Functions | IP Table Setup**.
2. Add, modify or delete entries in the IP table.

3. A defined IP table can be saved to a file or sent to the device.

Edit the control system's IP table to include an entry for the TPS-6X. The entry should list the TPS-6X's IP ID (specified on the TPS-6X's IP table) and the internal gateway IP address 127.0.0.1.

Problem Solving

Troubleshooting

The following table provides corrective action for possible trouble situations. If further assistance is required, please contact a Crestron customer service representative.

TPS-6X Troubleshooting

TROUBLE	POSSIBLE CAUSE(S)	CORRECTIVE ACTION
Device does not function.	Battery is discharged.	Place the TPS-6X on the (included) TPS-6X-DS (or with the TPS-6XNL, the TPS-6XNL-DS) Docking Station and charge the battery.
	TPS-6X is not receiving power.	Verify power to (included) TPS-6X-IMCW Interface Module.
	Device is not communicating with the network.	Use Crestron Toolbox to poll the network. Verify network connection to the device.
	Device is not receiving power from a Crestron power source.	Use the provided Crestron power source. Verify connections.
	Device is not receiving sufficient power.	Use the Crestron Power Calculator to help calculate how much power is needed for the system.
	Rear panel battery switch is OFF.	Move rear panel battery switch to ON position.
Touchpanel is not responding.	Touchpanel Net ID is not set to match the Net ID in the SIMPL program.	Use Crestron Toolbox to poll the network. Verify the Net ID for the touchpanel is properly set to match the Net ID in the SIMPL program.
	Touchpanel Net ID is not unique; two or more units share the same ID.	Use Crestron Toolbox to poll the network and verify that each ID is used only once.
	No IP address configured/obtained on the TPS-6X.	Use the internal setup menu (refer to "COMM" which starts on page 19) or Crestron Toolbox to create/verify Ethernet settings.
	Invalid control system IP address / IP ID set up on the TPS-6X.	The IP address (or host name) for the control system is invalid or the IP ID does not match the one defined in the SIMPL program. Refer to "COMM" which starts on page 19 to define IP addresses.

(Continued on following page)

TPS-6X Troubleshooting (Continued)

TROUBLE	POSSIBLE CAUSE(S)	CORRECTIVE ACTION
Touchpanel is not responding (Continued).	Touchpanel is set to wrong RF channel.	Refer to “WIRELESS” which starts on page 27 to verify the touchpanel RF channel is set to match the CEN(I)-HPRFGW gateway’s channel ID.
	Touchpanel RF ID does not match the RF ID in the SIMPL program.	Use Crestron Toolbox to poll the network. Check the RF ID for the touchpanel. Then refer to “WIRELESS” which starts on page 27 to set its RF ID to match the RF ID in the SIMPL program.
	Touchpanel is out of range of CEN(I)-HPRFGW gateway.	Position the touchpanel within operating range or relocate the CEN(I)-HPRFGW. Refer to “Specifications” which starts on page 5 for operating range details.
Touchpanel display is dark.	Standby timeout has elapsed.	Touch the screen to reactivate.
Unexpected response from touchpanel.	Touchpanel is incorrectly calibrated.	Recalibrate the touchscreen (refer to “Configuring the Touchpanel” which starts on page 13 and “CALIBRATION MENU” on page 15).
TPS-6X boots up with message saying “Your desired page was not found.”	Invalid VT Pro-e project or no VT Pro-e project is loaded.	Load/reload VT Pro-e project using Crestron Toolbox.

Check Network Wiring**Use the Right Wire**

In order to ensure optimum performance over the full range of your installation topology, Crestron Certified Wire and only Crestron Certified Wire may be used. Failure to do so may incur additional charges if support is required to identify performance deficiencies because of using improper wire.

Calculate Power

CAUTION: Use only Crestron power supplies for Crestron equipment. Failure to do so could cause equipment damage or void the Crestron warranty.

CAUTION: Provide sufficient power to the system. Insufficient power can lead to unpredictable results or damage to the equipment. Please use the Crestron Power Calculator to help calculate how much power is needed for the system (www.crestron.com/calculators).

When calculating the length of wire for a particular Cresnet run, the wire gauge and the Cresnet power usage of each network unit to be connected must be taken into consideration. Use Crestron Certified Wire only. If Cresnet units are to be daisy-chained on the run, the Cresnet power usage of each network unit to be daisy-chained must be added together to determine the Cresnet power usage of the entire chain. If the unit is home-run from a Crestron system power supply network port, the

Cresnet power usage of that unit is the Cresnet power usage of the entire run. The wire gauge and the Cresnet power usage of the run should be used in the following equation to calculate the cable length value on the equation's left side.

Cable Length Equation

$$L < \frac{40,000}{R \times P}$$

Where: L = Length of run (or chain) in feet
 R = 6 Ohms (Crestron Certified Wire: 18 AWG (0.75 MM²))
 or 1.6 Ohms (Cresnet HP: 12 AWG (4 MM²))
 P = Cresnet power usage of entire run (or chain)

Make sure the cable length value is less than the value calculated on the right side of the equation. For example, a Cresnet run using 18 AWG Crestron Certified Wire and drawing 20 watts should not have a length of run more than 333 feet. If Cresnet HP is used for the same run, its length could extend to 1250 feet.

NOTE: All Crestron certified Cresnet wiring must consist of two twisted pairs. One twisted pair is the +24V conductor and the GND conductor and the other twisted pair is the Y conductor and the Z conductor.

Strip and Tin Wire

When daisy-chaining Cresnet units, strip the ends of the wires carefully to avoid nicking the conductors. Twist together the ends of the wires that share a pin on the network connector and tin the twisted connection. Apply solder only to the ends of the twisted wires. Avoid tinning too far up the wires or the end becomes brittle. Insert the tinned connection into the Cresnet connector and tighten the retaining screw. Repeat the procedure for the other three conductors.

Add Hubs

For larger networks (i.e., greater than 28 network devices), it may become necessary to add a Cresnet Hub/Repeater (CNXHUB) to maintain signal quality throughout the network. Also, for networks with lengthy cable runs it may be necessary to add a Hub/Repeater after only 20 devices.

Reference Documents

The latest version of all documents mentioned within the guide can be obtained from the Crestron website (www.crestron.com/manuals). This link will provide a list of product manuals arranged in alphabetical order by model number.

List of Related Reference Documents

DOCUMENT TITLE
2-Series Control Systems Reference Guide
CEN-HPRFGW High Powered RF Gateway
Crestron e-Control Reference Guide
TPS-6X Roaming Quickstart
TPS-6X-DS & TPS-6XNL-DS Docking Stations for the TPS-6X Series
TPS-6X-IMCW Interface Module

Further Inquiries

If you cannot locate specific information or have questions after reviewing this guide, please take advantage of Crestron's award winning customer service team by calling Crestron at 1-888-CRESTRON [1-888-273-7876].

You can also log onto the online help section of the Crestron website (www.crestron.com/onlinehelp) to ask questions about Crestron products. First-time users will need to establish a user account to fully benefit from all available features.

Future Updates

As Crestron improves functions, adds new features and extends the capabilities of the TPS-6X, additional information may be made available as manual updates. These updates are solely electronic and serve as intermediary supplements prior to the release of a complete technical documentation revision.

Check the Crestron website periodically for manual update availability and its relevance. Updates are identified as an “Addendum” in the Download column.

Appendix A: The RF Spectrum

Crestron’s RF network provides 16 RF channels in the 2.4GHz ISM band, specifically IEEE 802.15.4 channels 11 through 26. The 16 channels define the frequencies at which the RF device will communicate.

RF devices on different channels will not communicate or interfere with each other. However, since some of the channels are in the 2.4GHz ISM band (as shown in the following diagram), interference can occur with other devices using this band, such as 802.11b/g Wi-Fi devices, Crestron infiNET™ devices or Zigbee devices, although the differing protocols will not allow a link to be established or data to be transferred. Wireless 2.4GHz telephones and microwave ovens may also cause interference with the network.

IEEE 802.15.4 channel selection (2400 MHz PHY)

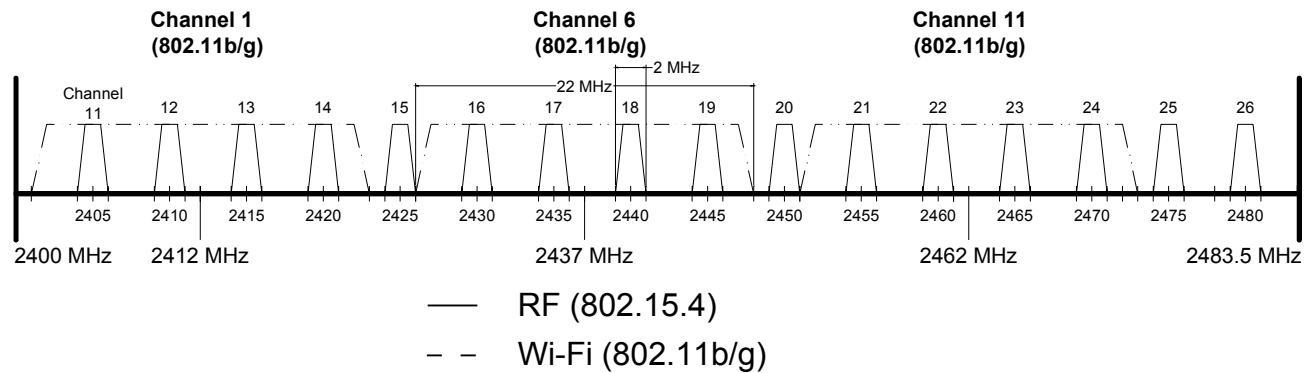

Appendix B: Optimum RF Reception Guidelines

Many factors can affect the reliability of RF communication between an RF gateway and an RF touchpanel. While an effort has been made to determine operating specifications, some specifications are not constant. RF Communication can be limited by several factors including but not limited to EMI (electromagnetic interference), intervening objects, antenna orientation and receiver placement. To obtain maximum reliability and performance, some basic rules for installing RF transceivers are listed below.

Minimize Interference

RF reception range can be hindered by spurious EMI noise that may interfere with or mask the desired frequency, thereby reducing useable range. EMI is generated by any electrical device at various RF noise levels depending on the device. Sources of EMI include computers, video equipment, digital processors, lighting dimmers, lighting ballasts, motors or any large AC source. Every effort should be made to separate any RF transceiver from these sources of RF noise including Audio Visual equipment in racks. If a gateway must be installed in an equipment rack, make sure you have ample separation between the equipment and the gateway.

Gateway Placement

Optimum reception for any RF transceiver is obtained by installing the gateway transceiver in an open area or shelf with a clear line of sight (no obstructions between gateway and receiver). Crestron recommends that the gateway is at least five to six feet high for best results. Avoid placing transceivers or transmitters at a low height or on the ground. Placing RF equipment near metal objects, walls, corners or metal enclosures will compromise RF propagation and reception. Try to avoid installing gateways in equipment racks, service rooms, electrical closets or in rooms other than that which the panel is located.

Antenna Orientation

The antenna orientation on Crestron gateways has considerable effect on range and reliability. The best orientation is unique to each installation. There are three possible antenna orientations:

- Point the antenna horizontally (parallel to the ground)
- Point the antenna vertically.
- Point the antenna at a right angle to the gateway.

Never point the antenna downward as this will decrease range and reliability. Refer to illustrations on the following pages for examples of the different antenna orientations.

NOTE: RF propagation is best from the sides of the antenna.

Horizontal Orientation

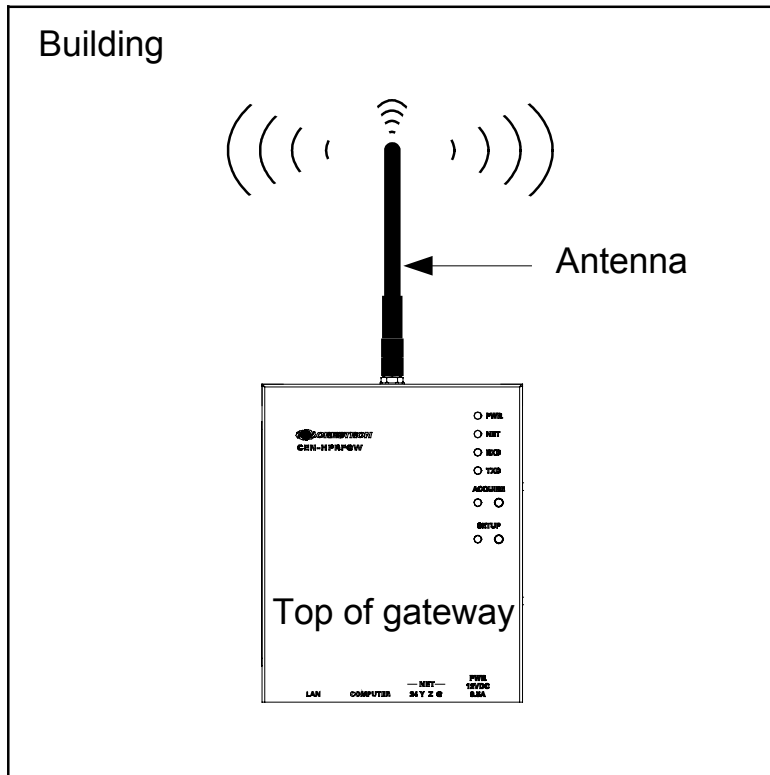

Vertical Orientation

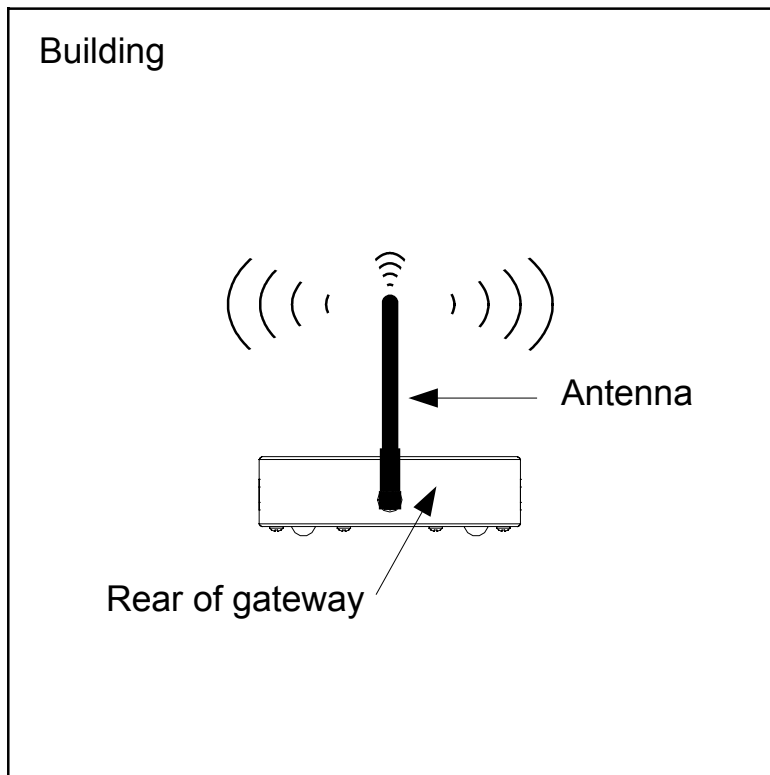

Right Angle Orientation

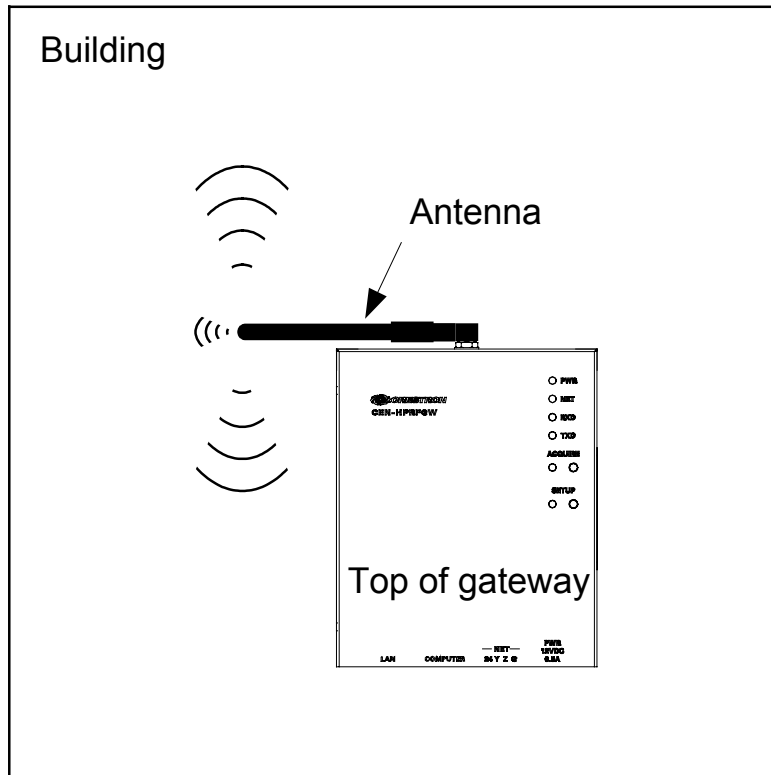

Software License Agreement

This License Agreement (“Agreement”) is a legal contract between you (either an individual or a single business entity) and Crestron Electronics, Inc. (“Crestron”) for software referenced in this guide, which includes computer software and as applicable, associated media, printed materials and “online” or electronic documentation (the “Software”).

BY INSTALLING, COPYING OR OTHERWISE USING THE SOFTWARE, YOU REPRESENT THAT YOU ARE AN AUTHORIZED DEALER OF CRESTRON PRODUCTS OR A CRESTRON AUTHORIZED INDEPENDENT PROGRAMMER AND YOU AGREE TO BE BOUND BY THE TERMS OF THIS AGREEMENT. IF YOU DO NOT AGREE TO THE TERMS OF THIS AGREEMENT, DO NOT INSTALL OR USE THE SOFTWARE.

IF YOU HAVE PAID A FEE FOR THIS LICENSE AND DO NOT ACCEPT THE TERMS OF THIS AGREEMENT, CRESTRON WILL REFUND THE FEE TO YOU PROVIDED YOU (1) CLICK THE DO NOT ACCEPT BUTTON, (2) DO NOT INSTALL THE SOFTWARE AND (3) RETURN ALL SOFTWARE, MEDIA AND OTHER DOCUMENTATION AND MATERIALS PROVIDED WITH THE SOFTWARE TO CRESTRON AT: CRESTRON ELECTRONICS, INC., 15 VOLVO DRIVE, ROCKLEIGH, NEW JERSEY 07647, WITHIN 30 DAYS OF PAYMENT.

LICENSE TERMS

Crestron hereby grants You and You accept a nonexclusive, nontransferable license to use the Software (a) in machine readable object code together with the related explanatory written materials provided by Crestron (b) on a central processing unit (“CPU”) owned or leased or otherwise controlled exclusively by You and (c) only as authorized in this Agreement and the related explanatory files and written materials provided by Crestron.

If this software requires payment for a license, you may make one backup copy of the Software, provided Your backup copy is not installed or used on any CPU. You may not transfer the rights of this Agreement to a backup copy unless the installed copy of the Software is destroyed or otherwise inoperable and You transfer all rights in the Software.

You may not transfer the license granted pursuant to this Agreement or assign this Agreement without the express written consent of Crestron.

If this software requires payment for a license, the total number of CPU’s on which all versions of the Software are installed may not exceed one per license fee (1) and no concurrent, server or network use of the Software (including any permitted back-up copies) is permitted, including but not limited to using the Software (a) either directly or through commands, data or instructions from or to another computer (b) for local, campus or wide area network, internet or web hosting services or (c) pursuant to any rental, sharing or “service bureau” arrangement.

The Software is designed as a software development and customization tool. As such Crestron cannot and does not guarantee any results of use of the Software or that the Software will operate error free and You acknowledge that any development that You perform using the Software or Host Application is done entirely at Your own risk.

The Software is licensed and not sold. Crestron retains ownership of the Software and all copies of the Software and reserves all rights not expressly granted in writing.

OTHER LIMITATIONS

You must be an Authorized Dealer of Crestron products or a Crestron Authorized Independent Programmer to install or use the Software. If Your status as a Crestron Authorized Dealer or Crestron Authorized Independent Programmer is terminated, Your license is also terminated.

You may not rent, lease, lend, sublicense, distribute or otherwise transfer or assign any interest in or to the Software.

You may not reverse engineer, decompile or disassemble the Software.

You agree that the Software will not be shipped, transferred or exported into any country or used in any manner prohibited by the United States Export Administration Act or any other export laws, restrictions or regulations (“Export Laws”). By downloading or installing the Software You (a) are certifying that You are not a national of Cuba, Iran, Iraq, Libya, North Korea, Sudan, Syria or any country to which the United States embargoes goods (b) are certifying that You are not otherwise prohibited from receiving the Software and (c) You agree to comply with the Export Laws.

If any part of this Agreement is found void and unenforceable, it will not affect the validity of the balance of the Agreement, which shall remain valid and enforceable according to its terms. This Agreement may only be modified by a writing signed by an authorized officer of Crestron. Updates may be licensed to You by Crestron with additional or different terms. This is the entire agreement between Crestron and You relating to the Software and it supersedes any prior representations, discussions, undertakings, communications or advertising relating to the Software. The failure of either party to enforce any right or take any action in the event of a breach hereunder shall constitute a waiver unless expressly acknowledged and set forth in writing by the party alleged to have provided such waiver.

If You are a business or organization, You agree that upon request from Crestron or its authorized agent, You will within thirty (30) days fully document and certify that use of any and all Software at the time of the request is in conformity with Your valid licenses from Crestron or its authorized agent.

Without prejudice to any other rights, Crestron may terminate this Agreement immediately upon notice if you fail to comply with the terms and conditions of this Agreement. In such event, you must destroy all copies of the Software and all of its component parts.

PROPRIETARY RIGHTS

Copyright. All title and copyrights in and to the Software (including, without limitation, any images, photographs, animations, video, audio, music, text and “applets” incorporated into the Software), the accompanying media and printed materials and any copies of the Software are owned by Crestron or its suppliers. The Software is protected by copyright laws and international treaty provisions. Therefore, you must treat the Software like any other copyrighted material, subject to the provisions of this Agreement.

Submissions. Should you decide to transmit to Crestron’s website by any means or by any media any materials or other information (including, without limitation, ideas, concepts or techniques for new or improved services and products), whether as information, feedback, data, questions, comments, suggestions or the like, you agree such submissions are unrestricted and shall be deemed non-confidential and you automatically grant Crestron and its assigns a non-exclusive, royalty-free, worldwide, perpetual, irrevocable license, with the right to sublicense, to use, copy, transmit, distribute, create derivative works of, display and perform the same.

Trademarks. CRESTRON and the Swirl Logo are registered trademarks of Crestron Electronics, Inc. You shall not remove or conceal any trademark or proprietary notice of Crestron from the Software including any back-up copy.

GOVERNING LAW

This Agreement shall be governed by the laws of the State of New Jersey, without regard to conflicts of laws principles. Any disputes between the parties to the Agreement shall be brought in the state courts in Bergen County, New Jersey or the federal courts located in the District of New Jersey. The United Nations Convention on Contracts for the International Sale of Goods shall not apply to this Agreement.

CRESTRON LIMITED WARRANTY

CRESTRON warrants that: (a) the Software will perform substantially in accordance with the published specifications for a period of ninety (90) days from the date of receipt and (b) that any hardware accompanying the Software will be subject to its own limited warranty as stated in its accompanying written material. Crestron shall, at its option, repair or replace or refund the license fee for any Software found defective by Crestron if notified by you within the warranty period. The foregoing remedy shall be your exclusive remedy for any claim or loss arising from the Software.

CRESTRON shall not be liable to honor warranty terms if the product has been used in any application other than that for which it was intended or if it as been subjected to misuse, accidental damage, modification or improper installation procedures. Furthermore, this warranty does not cover any product that has had the serial number or license code altered, defaced, improperly obtained or removed.

Notwithstanding any agreement to maintain or correct errors or defects, Crestron shall have no obligation to service or correct any error or defect that is not reproducible by Crestron or is deemed in Crestron’s reasonable discretion to have resulted from (1) accident; unusual stress; neglect; misuse; failure of electric power, operation of the Software with other media not meeting or not maintained in accordance with the manufacturer’s specifications or causes other than ordinary use; (2) improper installation by anyone other than Crestron or its authorized agents of the Software that deviates from any operating procedures established by Crestron in the material and files provided to You by Crestron or its authorized agent; (3) use of the Software on unauthorized hardware or (4) modification of, alteration of or additions to the Software undertaken by persons other than Crestron or Crestron’s authorized agents.

ANY LIABILITY OF CRESTRON FOR A DEFECTIVE COPY OF THE SOFTWARE WILL BE LIMITED EXCLUSIVELY TO REPAIR OR REPLACEMENT OF YOUR COPY OF THE SOFTWARE WITH ANOTHER COPY OR REFUND OF THE INITIAL LICENSE FEE CRESTRON RECEIVED FROM YOU FOR THE DEFECTIVE COPY OF THE PRODUCT. THIS WARRANTY SHALL BE THE SOLE AND EXCLUSIVE REMEDY TO YOU. IN NO EVENT SHALL CRESTRON BE LIABLE FOR INCIDENTAL, CONSEQUENTIAL, SPECIAL OR PUNITIVE DAMAGES OF ANY KIND (PROPERTY OR ECONOMIC DAMAGES INCLUSIVE), EVEN IF A CRESTRON REPRESENTATIVE HAS BEEN ADVISED OF THE POSSIBILITY OF SUCH DAMAGES OR OF ANY CLAIM BY ANY THIRD PARTY. CRESTRON MAKES NO WARRANTIES, EXPRESS OR IMPLIED, AS TO TITLE OR INFRINGEMENT OF THIRD-PARTY RIGHTS, MERCHANTABILITY OR FITNESS FOR ANY PARTICULAR PURPOSE, OR ANY OTHER WARRANTIES, NOR AUTHORIZES ANY OTHER PARTY TO OFFER ANY WARRANTIES, INCLUDING WARRANTIES OF MERCHANTABILITY FOR THIS PRODUCT. THIS WARRANTY STATEMENT SUPERSEDES ALL PREVIOUS WARRANTIES.

Return and Warranty Policies

Merchandise Returns / Repair Service

1. No merchandise may be returned for credit, exchange or service without prior authorization from CRESTRON. To obtain warranty service for CRESTRON products, contact an authorized CRESTRON dealer. Only authorized CRESTRON dealers may contact the factory and request an RMA (Return Merchandise Authorization) number. Enclose a note specifying the nature of the problem, name and phone number of contact person, RMA number and return address.
2. Products may be returned for credit, exchange or service with a CRESTRON Return Merchandise Authorization (RMA) number. Authorized returns must be shipped freight prepaid to CRESTRON, 6 Volvo Drive, Rockleigh, N.J. or its authorized subsidiaries, with RMA number clearly marked on the outside of all cartons. Shipments arriving freight collect or without an RMA number shall be subject to refusal. CRESTRON reserves the right in its sole and absolute discretion to charge a 15% restocking fee plus shipping costs on any products returned with an RMA.
3. Return freight charges following repair of items under warranty shall be paid by CRESTRON, shipping by standard ground carrier. In the event repairs are found to be non-warranty, return freight costs shall be paid by the purchaser.

CRESTRON Limited Warranty

CRESTRON ELECTRONICS, Inc. warrants its products to be free from manufacturing defects in materials and workmanship under normal use for a period of three (3) years from the date of purchase from CRESTRON, with the following exceptions: disk drives and any other moving or rotating mechanical parts, pan/tilt heads and power supplies are covered for a period of one (1) year; touchscreen display and overlay components are covered for 90 days; batteries and incandescent lamps are not covered.

This warranty extends to products purchased directly from CRESTRON or an authorized CRESTRON dealer. Purchasers should inquire of the dealer regarding the nature and extent of the dealer's warranty, if any.

CRESTRON shall not be liable to honor the terms of this warranty if the product has been used in any application other than that for which it was intended or if it has been subjected to misuse, accidental damage, modification or improper installation procedures. Furthermore, this warranty does not cover any product that has had the serial number altered, defaced or removed.

This warranty shall be the sole and exclusive remedy to the original purchaser. In no event shall CRESTRON be liable for incidental or consequential damages of any kind (property or economic damages inclusive) arising from the sale or use of this equipment. CRESTRON is not liable for any claim made by a third party or made by the purchaser for a third party.

CRESTRON shall, at its option, repair or replace any product found defective, without charge for parts or labor. Repaired or replaced equipment and parts supplied under this warranty shall be covered only by the unexpired portion of the warranty.

Except as expressly set forth in this warranty, CRESTRON makes no other warranties, expressed or implied, nor authorizes any other party to offer any warranty, including any implied warranties of merchantability or fitness for a particular purpose. Any implied warranties that may be imposed by law are limited to the terms of this limited warranty. This warranty statement supersedes all previous warranties.

Trademark Information

All brand names, product names and trademarks are the sole property of their respective owners. Windows is a registered trademark of Microsoft Corporation. Windows95/98/Me/XP/Vista/7 and WindowsNT/2000 are trademarks of Microsoft Corporation.



Crestron Electronics, Inc.
15 Volvo Drive Rockleigh, NJ 07647
Tel: 888.CRESTRON
Fax: 201.767.7576
www.crestron.com

Operations Guide – DOC. 6875B
(2025141)
01.10
Specifications subject to
change without notice.